

Lassen™ iQ GPS Receiver

System Designer Reference Manual



Part Number 54854-00
Revision A
February 2005

Corporate Office

Trimble Navigation Limited
Components Technologies Division
749 North Mary Avenue
Post Office Box 3642
Sunnyvale, CA 94088-3642
U.S.A.
Phone: +1-408-481-8940, 1-800-545-7762
Fax: +1-408-481-7744
www.trimble.com

Support Offices

Trimble Navigation Limited
Components Technologies Division
749 North Mary Avenue
Post Office Box 3642
Sunnyvale, CA 94088-3642
U.S.A.
Phone: +1-408-481-8940, 1-800-545-7762
Fax: +1-408-481-7744

Trimble Navigation Europe Limited
Trimble House
Meridian Office Park
Osborn Way, Hook
Hampshire RG27 9HX
England
Phone: +44-1256-760-150
Fax: +44-1-256-760-148

Copyright and Trademarks

© 2005 Trimble Navigation Limited. All rights reserved. No part of this manual may be copied, reproduced, translated, or reduced to any electronic medium or machine-readable form for any use other than with the Lassen™ iQ GPS Receiver.

The Globe & Triangle logo, Trimble, Colossus, FirstGPS, and Lassen, are trademarks of Trimble Navigation Limited.

The Sextant logo with Trimble is a trademark of Trimble Navigation Limited, registered in the United States Patent and Trademark Office.

All other trademarks are the property of their respective owners.

Release Notice

This is the February 2005 release (Revision A) of the Lassen™ iQ GPS Receiver System Designer Reference Manual, part number 54854-00.

The following limited warranties give you specific legal rights. You may have others, which vary from state/jurisdiction to state/jurisdiction.

Waste Electrical and Electronic Equipment (WEEE) Notice

This Trimble product is furnished on an OEM basis. By incorporating this Trimble product with your finished goods product(s) you shall be deemed the “producer” of all such products under any laws, regulations or other statutory scheme providing for the marking, collection, recycling and/or disposal of electrical and electronic equipment (collectively, “WEEE Regulations”) in any jurisdiction whatsoever, (such as for example national laws implementing EC Directive 2002/96 on waste electrical and electronic equipment, as amended), and shall be solely responsible for complying with all such applicable WEEE Regulations.

Hardware Limited Warranty

Trimble warrants that this Trimble hardware product (the “Product”) shall be free from defects in materials and workmanship and will substantially conform to Trimble’s applicable published specifications for the Product for a period of one (1) year, starting from the date of delivery. The warranty set forth in this paragraph shall not apply to software/firmware products.

Software and Firmware License, Limited Warranty

This Trimble software and/or firmware product (the "Software") is licensed and not sold. Its use is governed by the provisions of the applicable End User License Agreement ("EULA"), if any, included with the Software. In the absence of a separate EULA included with the Software providing different limited warranty terms, exclusions, and limitations, the following terms and conditions shall apply. Trimble warrants that this Trimble Software product will substantially conform to Trimble's applicable published specifications for the Software for a period of ninety (90) days, starting from the date of delivery.

Warranty Remedies

Trimble's sole liability and your exclusive remedy under the warranties set forth above shall be, at Trimble's option, to repair or replace any Product or Software that fails to conform to such warranty ("Nonconforming Product"), or refund the purchase price paid by you for any such Nonconforming Product, upon your return of any Nonconforming Product to Trimble in accordance with Trimble's standard return material authorization procedures.

Warranty Exclusions and Disclaimer

These warranties shall be applied only in the event and to the extent that: (i) the Products and Software are properly and correctly installed, configured, interfaced, maintained, stored, and operated in accordance with Trimble's relevant operator's manual and specifications, and; (ii) the Products and Software are not modified or misused.

The preceding warranties shall not apply to, and Trimble shall not be responsible for defects or performance problems resulting from (i) the combination or utilization of the Product or Software with products, information, data, systems or devices not made, supplied or specified by Trimble; (ii) the operation of the Product or Software under any specification other than, or in addition to, Trimble's standard specifications for its products; (iii) the unauthorized modification or use of the Product or Software; (iv) damage caused by accident, lightning or other electrical discharge, fresh or salt water immersion or spray; or (v) normal wear and tear on consumable parts (e.g., batteries).

THE WARRANTIES ABOVE STATE TRIMBLE'S ENTIRE LIABILITY, AND YOUR EXCLUSIVE REMEDIES, RELATING TO PERFORMANCE OF THE PRODUCTS AND SOFTWARE. EXCEPT AS OTHERWISE EXPRESSLY PROVIDED HEREIN, THE PRODUCTS, SOFTWARE, AND ACCOMPANYING DOCUMENTATION AND MATERIALS ARE PROVIDED "AS-IS" AND WITHOUT EXPRESS OR IMPLIED WARRANTY OF ANY KIND BY EITHER TRIMBLE NAVIGATION LIMITED OR ANYONE WHO HAS BEEN INVOLVED IN ITS CREATION, PRODUCTION, INSTALLATION, OR DISTRIBUTION, INCLUDING, BUT NOT LIMITED TO, THE IMPLIED WARRANTIES OF MERCHANTABILITY AND FITNESS FOR A PARTICULAR PURPOSE, TITLE, AND NONINFRINGEMENT. THE STATED EXPRESS WARRANTIES ARE IN LIEU OF ALL OBLIGATIONS OR LIABILITIES ON THE PART OF TRIMBLE ARISING OUT OF, OR IN CONNECTION WITH, ANY PRODUCTS OR SOFTWARE. SOME STATES AND JURISDICTIONS DO NOT ALLOW LIMITATIONS ON DURATION OR THE EXCLUSION OF AN IMPLIED WARRANTY, SO THE ABOVE LIMITATION MAY NOT APPLY TO YOU.

TRIMBLE NAVIGATION LIMITED IS NOT RESPONSIBLE FOR THE OPERATION OR FAILURE OF OPERATION OF GPS SATELLITES OR THE AVAILABILITY OF GPS SATELLITE SIGNALS.

Limitation of Liability

TRIMBLE'S ENTIRE LIABILITY UNDER ANY PROVISION HEREIN SHALL BE LIMITED TO THE GREATER OF THE AMOUNT PAID BY YOU FOR THE PRODUCT OR SOFTWARE LICENSE OR U.S.\$25.00. TO THE MAXIMUM EXTENT PERMITTED BY APPLICABLE LAW, IN NO EVENT SHALL TRIMBLE OR ITS SUPPLIERS BE LIABLE FOR ANY INDIRECT, SPECIAL, INCIDENTAL, OR CONSEQUENTIAL DAMAGES WHATSOEVER UNDER ANY CIRCUMSTANCE OR LEGAL THEORY RELATING IN ANY WAY TO THE PRODUCTS, SOFTWARE, AND ACCOMPANYING DOCUMENTATION AND MATERIALS, (INCLUDING, WITHOUT LIMITATION, DAMAGES FOR LOSS OF BUSINESS PROFITS, BUSINESS INTERRUPTION, LOSS OF BUSINESS INFORMATION, OR ANY OTHER PECUNIARY LOSS), REGARDLESS OF WHETHER TRIMBLE HAS BEEN ADVISED OF THE POSSIBILITY OF ANY SUCH LOSS AND REGARDLESS OF THE COURSE OF DEALING WHICH DEVELOPS OR HAS DEVELOPED BETWEEN YOU AND TRIMBLE. BECAUSE SOME STATES AND JURISDICTIONS DO NOT ALLOW THE EXCLUSION OR LIMITATION OF LIABILITY FOR CONSEQUENTIAL OR INCIDENTAL DAMAGES, THE ABOVE LIMITATION MAY NOT APPLY TO YOU.

Table of Contents

1	Starter Kit	
	Product Overview2
	Starter Kit3
	Receiver Performance5
	Interface Protocols6
	Ordering Starter Kit Components7
	Starter Kit Interface Unit8
	Power	13
	Hardware Setup	15
	Software Toolkit	17
2	Hardware Integration	
	General Description	20
	Connectors	21
	Power Requirements	25
	Serial Interface	27
	Serial Port Connections	28
	Pulse-Per-Second (PPS)	31
	Mounting	32
	GPS Antennas	33
3	Software Interface	
	Start-up	38
	Communicating with the Lassen iQ GPS Receiver	39
	Port Protocol and Data Output Options	42
	Custom Port Configuration	47
	Timing Applications	51
	Known Anomalies in Firmware Release 1.10	52
4	Operation and Performance	
	Introduction	54
	GPS Satellite Message	55
	Satellite Acquisition and Time to First Fix	56
	Satellite Mask Settings	60
	Standard Operating Modes	63

Table of Contents

Differential GPS Operating Modes	64
Position Accuracy	65
Coordinate Systems	66
Performance Characteristics	68
Lassen iQ GPS Receiver Sensitivity Modes.	70
Lassen iQ GPS Receiver Aided GPS Feature.	75
GPS Timing	78
Pulse-Per-Second (PPS)	80
System Architecture	82
A Trimble Standard Interface Protocol (TSIP)	
Interface Scope	86
Packet Structure	87
Automatic Output Packets	88
Customizing Receiver Operations	89
Automatic Position and Velocity Reports	89
Initialization Packets to Speed Start-up	90
Packets Output at Power-Up	91
Timing Packets	91
Satellite Data Packets	92
Backwards Compatibility.	92
Recommended TSIP Packets	93
Command Packets Sent to the Receiver	94
Report Packets Sent by the Receiver to the User	96
Key Setup Parameters or Packet BB	97
Packet Descriptions	102
TAIP Message Output (Packet 0x7E)	145
TSIP Superpackets	156
B TSIP Tool kit User's Guide	
iQ_Monitor	165

C	Trimble ASCII Interface Protocol (TAIP)	
	Message Format	169
	Sample PV Message	173
	Time and Distance Reporting	174
	Latitude and Longitude Conversion	176
	Message Data Strings	177
	Communication Scheme for TAIP	200
D	GPSSK User's Guide (TAIP)	
E	NMEA 0183	
	The NMEA 0183 Communication Interface	210
	NMEA 0183 Message Format	211
	Field Definitions	212
	NMEA 0183 Message Options	214
	NMEA 0183 Message Formats	215
	Exception Behavior	222
F	Specifications and Mechanical Drawings	
	Lassen iQ GPS Receiver Specifications	226
	Ultra Compact Embedded Antenna	232
	Compact Magnetic Mount Antenna	235
	Compact Unpackaged Antenna	240
G	Glossary	

Table of Contents

About this Manual

Welcome to System Designer Reference Manual for the Lassen iQ GPS receiver. This manual describes how to integrate and operate the Lassen iQ GPS receiver.

If you are not familiar with GPS, visit Trimble's website, www.trimble.com, for an interactive look at Trimble and GPS.

Trimble assumes that you are familiar with Microsoft Windows and know how to use a mouse, select options from menus and dialogs, make selections from lists, and refer to online help.

Technical Assistance

If you have a problem and cannot find the information you need in the product documentation, contact the Trimble Technical Assistance Center at 800-767-4822.

Your Comments

Your feedback about the supporting documentation helps us to improve it with each revision. To forward your comments, send an e-mail to ReaderFeedback@trimble.com.

Starter Kit

- Product Overview
- Starter Kit
- Receiver Performance
- Interface Protocols
- Ordering Starter Kit Components
- Starter Kit Interface Unit
- Power
- Hardware Setup
- Software Toolkit

Product Overview

The Lassen iQ GPS receiver is a full featured, ultra low power receiver on a miniature form factor, suitable for a variety of mobile, embedded applications. The Lassen iQ GPS receiver incorporates Trimble's FirstGPS™ architecture in the form of two ASICs: Colossus RF down converter and IO-C33 baseband chip.

The IO-C33 integrates Trimble's IO digital signal processor with the Epson C33 RISC processor, real-time clock, UART, and 1Mbit memory. Together with the colossus RF, this implementation of FirstGPS technology makes possible one of the smallest (26 mm x 26 mm x 6mm) and lowest power (less than 89 mW) GPS modules available.

The Lassen iQ GPS receiver outputs a complete position, velocity, and time (PVT) solution in the NMEA Version 3.0 ASCII protocol, the Trimble ASCII Interface Protocol (TAIP), and the Trimble TSIP binary protocol. A Pulse-Per-Second signal is available for very accurate timing applications.

Starter Kit

The Starter Kit makes it simple to evaluate the Lassen iQ GPS receiver's exceptional performance. The Starter Kit can be used as a platform for configuring the receiver module and as a platform for troubleshooting your design. The Starter Kit includes:

- Shielded Lassen iQ GPS module mounted on an interface motherboard in a durable metal enclosure. The motherboard accepts 9 - 32 VDC power and provides regulated +3.3V power to the Lassen iQ GPS receiver. The motherboard also contains:
 - 3.6V lithium battery that provides back-up power to the receiver.
 - Circuitry to convert the TTL output to RS-232, enabling the user to connect the RS-232 ports in the Starter Kit to the PC COM port via an RS-232 cable connection.
- Compact Magnetic-Mount GPS Antenna with a 5 meter cable.
- Ultra-Compact Embedded Antenna with an 8 cm cable.
- 9-pin RS-232 interface cable.
- AC/DC power supply adapter (input: 100-240VAC, output: 12 VDC).
- DC power cable.
- Cigarette lighter adapter power cable.
- CD containing software tools used to communicate with the receiver, the System Designer Reference Manual, and "C" programming source routines to be used as software templates for communicating directly with the receiver.

Removing the Lassen iQ GPS Module

The Lassen iQ GPS module is secured to the motherboard with double-sided adhesive tape allowing for easy removal and integration with the user's application. (The adhesive tape used by Trimble is 3M Scotch, part number 4945).

Follow these steps to remove the module from the motherboard:

- Unplug the I/O cable and the RF cable from the module.
- Use a small flat-head screw driver to pry the Lassen iQ GPS receiver module off the motherboard.

Warning – When the Lassen iQ GPS receiver module is removed from the motherboard, the double-sided tape loses some of its adhesive quality. This adhesive tape may only be re-used for laboratory testing. The original adhesive tape should not be re-used for drive testing the Starter Kit interface unit because the module could loosen and cause short circuit when contacting other motherboard components. If drive testing is required, use a new piece of double-sided adhesive tape to re-attach the Lassen iQ GPS receiver module to the motherboard.

Receiver Performance

The Lassen iQ GPS receiver is a complete 12-channel parallel tracking GPS receiver designed to operate with the L1 frequency, Standard Position Service, Coarse Acquisition code. Using two highly integrated Trimble custom integrated circuits, the receiver is designed in a modular format especially suited for embedded applications where small size and extremely low power consumption are required. The receiver features Trimble's latest signal processing code, a high-gain RF section for compatibility with standard 27 dB active gain GPS antennas, and a CMOS TTL level pulse-per-second (PPS) output for timing applications or for use as a general purpose synchronization signal.

The Lassen iQ GPS receiver acquires a position fix with minimal delay after power cycling. The battery back-up RAM is used to keep the Real Time clock (RTC) alive, and to store the following:

- Almanac
- Ephemeris
- Last position

User settings such as port parameters, NMEA, and TAIP configurations can be stored in the receiver's non-volatile (Flash) memory. These settings are retained without application of main power or battery back-up power.

The Lassen iQ GPS receiver has two configurable serial I/O communication ports.

Warning – When customizing port assignments or characteristics, confirm that your changes do not affect your ability to communicate with the receiver (see Chapter 3, Software Interface).

Interface Protocols

The Lassen iQ GPS receiver operates using one of three protocols — Trimble Standard Interface Protocol (TSIP), Trimble ASCII Interface Protocol (TAIP), or NMEA 0183. Protocol selection and port characteristics are user configurables. The factory default settings are:

- Port 1, TSIP bi-directional
- Port 2, NMEA 0183 OUT/RTCM SC-104 V2.1 IN

TSIP

TSIP is a powerful binary packet protocol that allows the system designer maximum configuration control over the GPS receiver for optimum performance in any number of applications. TSIP supports over 20 commands and their associated response packets for use in configuring the Lassen iQ GPS receiver to meet user requirements.

TAIP

TAIP is the Trimble ASCII interface protocol designed specifically for vehicle tracking applications. It is a bi-directional protocol using simple ASCII commands with the associated ASCII responses.

NMEA

NMEA 0183 is an industry standard protocol common to marine applications. NMEA provides direct compatibility with other NMEA-capable devices such as chart plotters, radars, etc. The Lassen iQ GPS receiver supports most NMEA messages for GPS navigation. NMEA messages and output rates can be user selected as required.

DGPS

The Lassen iQ GPS receiver can be configured for RTCM SC-104 input which is the GPS industry standard for differential correction data. The receive side of Port 2 is factory configured to accept RTCM data.

Ordering Starter Kit Components

The Lassen iQ GPS receiver is available in a Starter Kit or as an individual module and associated antenna. The Starter Kit (PN 51099-00) includes all the components necessary to quickly test and integrate the module:

- Compact Magnetic-Mount Antenna with 5m cable
- Ultra-Compact Embedded Antenna with 8cm cable
- AC/DC power supply adapter
- DC Power cable (3-wire)
- RS-232 interface cable DB9M/DB9F (pin to pin)
- Cigarette lighter adapter power cable
- CD-ROM containing software tools and the System Designer Reference Manual

Table 1.1 provides ordering information for the Lassen iQ GPS module and the associated antennas and cables.

Table 1.1 Lassen iQ GPS Receiver Ordering Information

Products	Part Number
Lassen iQ GPS receiver Module	46240-10/46240-20
Lassen iQ GPS receiver Starter Kit	51099-00
Antenna transition cable, MCX-HFL connector	47274
Antenna transition cable, SMA-HFL connector	49894-05
Ultra-Compact Embedded Antenna, 3.3V, 8cm cable	45336-00
Compact Unpackaged Antenna, 3V, 11cm cable, MCX connector	39265-51
Compact Magnetic Mount Antenna, 3V, 5m cable, MCX connector	39265-50
Compact Magnetic Mount Antenna, 3V, 5m cable, SMA connector	39265-52

Note – Part numbers are subject to change. Confirm part numbers with your Trimble representative when placing your order.

Starter Kit Interface Unit

The Starter Kit interface unit consists of a Lassen iQ GPS module attached to an interface motherboard, housed in a sturdy metal enclosure. This packaging simplifies testing and evaluation of the module by providing two RS-232 serial interfaces which are compatible with most PC communication ports. Power (9-32 VDC) is supplied through the power connector on the front of the interface unit. The motherboard features a switching power supply which converts this voltage input to the 3.3 volts required by the module. The two DB9 connectors allow for easy connection to a PC serial port using the serial interface cable provided in the Starter Kit. The metal enclosure protects the module and the motherboard for testing outside of the laboratory environment.

The Lassen iQ GPS receiver is a single module encased in a sturdy metal enclosure. The dimensions of the receiver in this enclosure are 26 mm H x 26 mm L x 6 mm H (1.02" W x 1.02" L x 0.24" H). A straight-in, panel-mount RF connector (J1) supports the GPS antenna connection. The center conductor of the coaxial connector also supplies +3.3 VDC for the Low Noise Amplifier of the active antenna. An 8-pin (2x4), 0.09 inch header (J2) supports the two serial interfaces (CMOS TTL level), the pulse-per-second (PPS) signal (CMOS TTL level), and the input power (+3.3 VDC). Figure 1.1 illustrates the module in the metal enclosure.

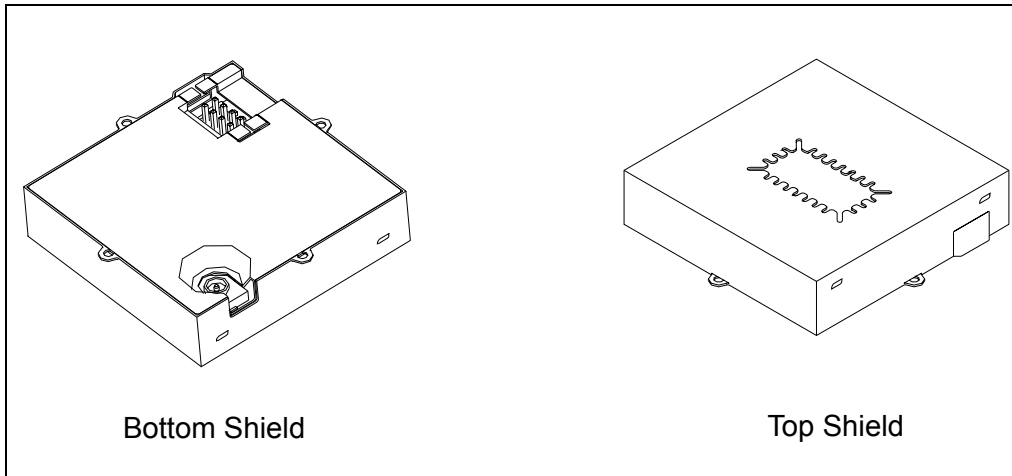

Figure 1.1 Lassen iQ GPS receiver Module

The interface motherboard includes a 9 to 32 VDC switching power supply which provides regulated +3.3 VDC power to the receiver, and contains circuitry which provides two RS-232 interface ports. A 3.6V lithium backup battery enables quick hot starts. The TTL level PPS is brought directly out to Pin 9 of the Port 2 DB9 connector on the front of the interface unit.

The Starter Kit includes an AC/DC converter for powering the module from an AC wall socket. The metal enclosure (see Figure 1.2.) provides 2 DB9 interface port connectors, an antenna connector, and a power connector. Port 1 and Port 2 are used for serial I/O.

The mounting plate is secured to the metal enclosure with four screws. The eight pin I/O header on the receiver module connects to a mating connector on a ribbon cable. The ribbon cable is attached to a mating I/O connector on the interface motherboard. Figure 1.2 illustrates the Starter Kit interface unit.

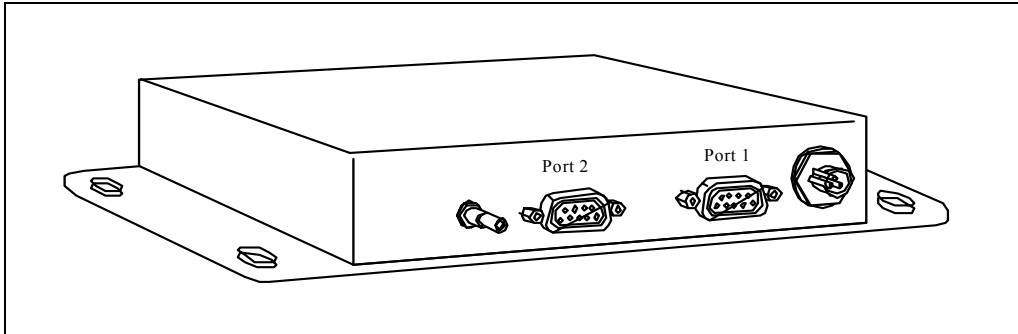

Figure 1.2 Starter Kit Interface Unit

Serial Port Interface

The Starter Kit interface unit is a DCE (Data Communication Equipment) device. To connect to a host computer, or DTE (Data Terminal Equipment) device, use a straight through cable. To connect a Differential Radio (DCE device) to the receiver (DCE Device) use a cross over cable or null modem cable.

Table 1.2 Port 1 Pinouts

Pin	Description
1	NC
2	TX
3	RX
4	NC
5	GND
6	NC
7	NC
8	NC
9	NC

Table 1.3 Port 2 Pinouts

Pin	Description
1	NC
2	TX
3	RX
4	NC
5	GND
6	NC
7	NC
8	NC
9	PPS Out

Pulse-Per-Second (PPS)

The Lassen iQ GPS receiver provides a four microsecond wide, CMOS compatible TTL level Pulse-Per-Second (PPS). The PPS is a positive pulse available on pin 9 of the port 2 DB9 connector of the interface unit (see Table 1.3). The rising edge of the PPS pulse is synchronized with respect to UTC. The timing accuracy is ± 50 nanoseconds when valid position fixes are being reported.

The rising edge of the pulse is typically less than 20 nanoseconds. The distributed impedance of the attached signal line and input circuit can affect the pulse shape and rise time. The PPS can drive a load up to 5mA without damaging the module. The falling edge of the pulse should not be used. The PPS is always on (early PPS) and is driven by the Real Time Clock (RTC) until the receiver acquires GPS time from the satellite and generates position fixes. The PPS is output immediately after main power is applied, and continues even if the receiver loses GPS lock. The drift of the PPS, when the receiver is not tracking satellites, is unspecified and should not be used for synchronization.

Note – Trimble has measured better than 50 nanosecond accuracy on the Lassen iQ GPS receiver's PPS signal in static mode. For more information on use of the Lassen iQ GPS receiver in timing applications, contact your Trimble sales representative.

Power

The Lassen iQ GPS receiver is designed for embedded applications and requires a regulated +3.3 VDC input (+3.0 to +3.6 VDC). The receiver provided in the Starter Kit is installed on a motherboard, providing a DC power regulator which converts a 9 to 32 VDC input to the regulated 3.3 VDC required by the receiver. Power can be applied to the interface unit using one of three options: the DC power cable (Figure 1.3), the AC/DC power converter (Figure 1.4), or the cigarette lighter adapter.

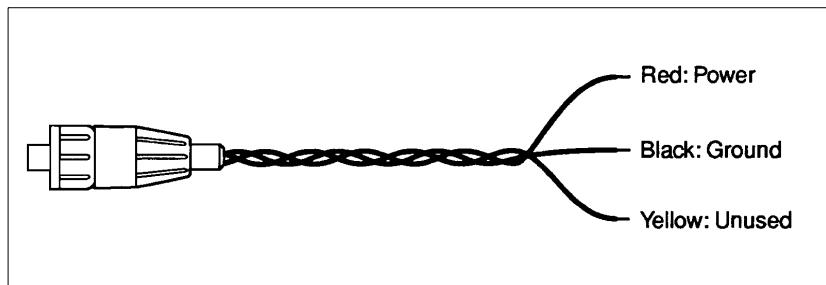

Figure 1.3 DC Power Cable

The DC power cable is ideal for bench-top or automotive testing environments. The power cable is terminated at one end with a 3-pin plastic connector which mates with the power connector on the metal enclosure. The un-terminated end of the cable provides easy connection to a DC power supply. Connect the red power lead to a source of DC positive +9 to +32 VDC, and connect the black power lead to ground. This connection supplies power to both the receiver and the antenna.

Note – To ensure compliance with CE conducted emissions requirements when using the DC power cable, the Starter Kit interface unit must be bonded to a ground plane.

Note – The yellow wire of the DC power cable is not used. Battery back-up power is provided by a factory installed 3.6V lithium battery on the motherboard.

The AC/DC power converter may be used as an alternate power source for the interface unit. The AC/DC power converter converts 110 or 220 VAC to a regulated 12 VDC compatible with the interface unit. The AC/DC power converter output cable is terminated with a 3-pin connector compatible with the power connector on the metal enclosure. The AC power cable is not provided in the kit, since this cable is country-specific. The input connector is a standard 3-prong connector used on many desktop PCs.

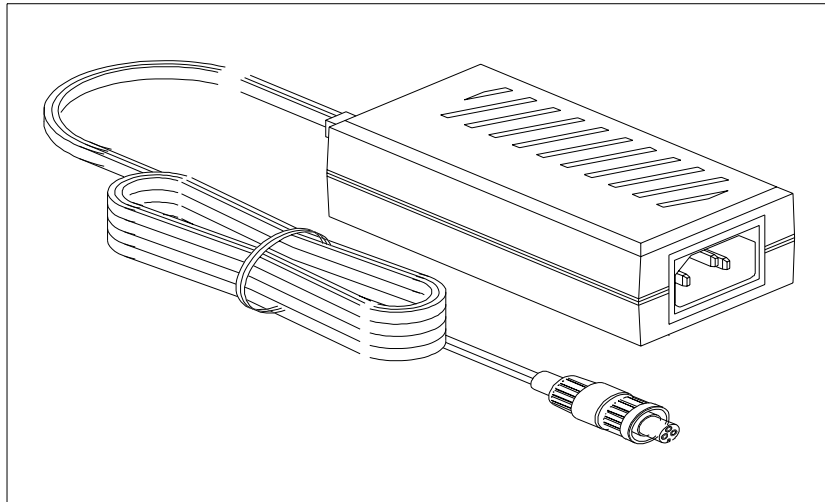

Figure 1.4 AC/DC Power Converter

Hardware Setup

The Lassen iQ GPS receiver supports the TSIP and NMEA protocols. A single port supports both the input/output of TSIP messages and the output of NMEA messages. Follow the steps below to setup the Starter Kit interface unit. Figure 1.5 illustrates the setup.

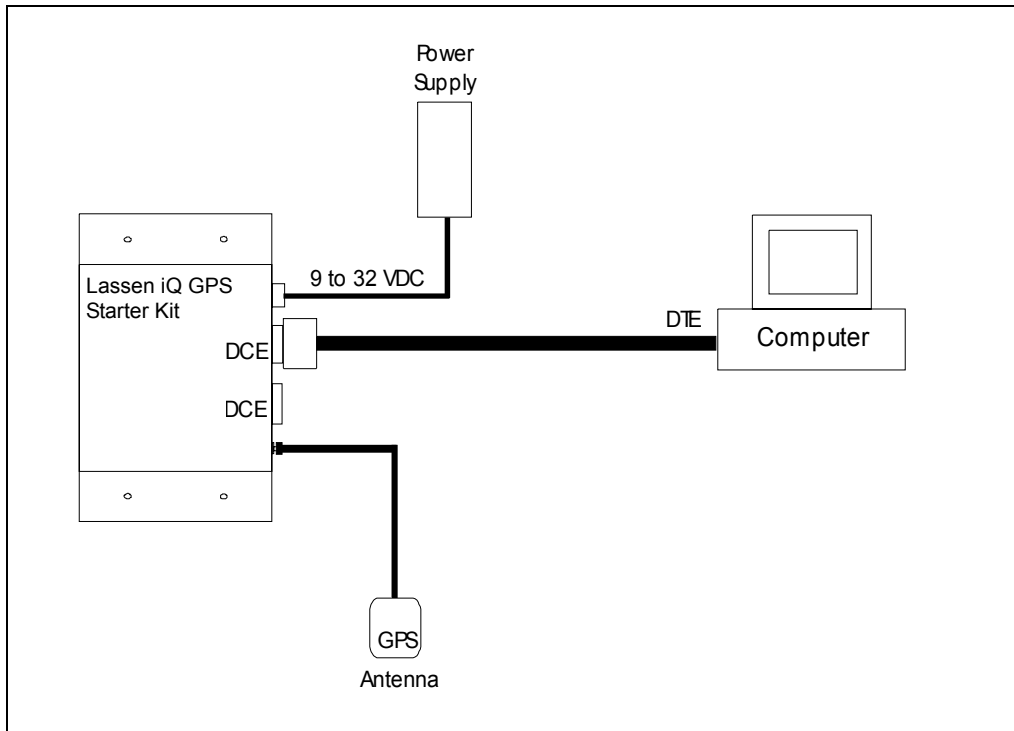

Figure 1.5 Starter Kit Interface Unit

1. For use with the TSIP or TAIP protocols, connect one end of the 9-pin serial interface cable to Port 1 (or Port 2 to view NMEA data) of the receiver module. Connect the other end of the cable to COM1 or COM2 on a PC. If your PC has a 25-pin communication port, a 9-pin-to-25-pin adapter may be required for this serial interface connection.
2. Connect the antenna cable to the interface unit. This connection is made by pushing the antenna cable connector onto the MCX connector on the module. Place the antenna so that it has a clear view of the sky.

Note – To remove the antenna cable, grasp the antenna mating MCX connector and pull from the MCX connector mounted on the interface unit.

3. Using either the DC power cable or an AC/DC power converter, connect to the 3-pin power connector on the interface unit.
 - DC Power Cable — connect the terminated end of the power cable to the power connector on the interface unit. Connect the red lead to DC positive voltage (+9 to +32 VDC) and black power lead to DC ground. The yellow wire is not used. Switch on the DC power source.
 - AC/DC Power Converter — connect the output cable of the converter to the 3-pin power connector on the interface unit. Using the appropriate 3-prong AC power cable (not provided), connect the converter to an AC wall socket (110 VAC or 220 VAC). The AC power cable is not provided in the Starter Kit.

Warning – If the Lassen iQ GPS Starter Kit is powered-up and attached to a PC COM port, the Windows operating system may recognize the Starter Kit as a new serial device and assign it to the mouse driver. This can cause erratic mouse control. To disable serial mouse detection at start-up, add one of the following lines in the BOOT.INI file in the root directory:
/NOSERIALMICE (detection is disabled on all serial ports) or
/NOSERIALMICE=COMx,COMy,COMz (detection is disabled on one or more specified com ports)

Software Toolkit

The CD provided in the Starter Kit contains the iQ_Monitor, the iQ_CHAT, and the GPSSK interface programs used to monitor GPS performance and to assist system integrators in developing a software interface for the GPS module. These applications are described in detail in Appendix B, *TSIP User's Guide*.

iQ_Monitor runs on the Windows 95/98/2000/XP platforms.

iQ_CHAT runs under the DOS operating system on a 386 or higher processor.

Following are quick start instructions for using the iQ_Monitor application to monitor the receiver's performance.

1. Connect one end of the serial interface cable to Port 1 of the interface unit. Connect the other end of the cable to the COM port of your PC.
2. Turn on the DC power source or plug in the AC/DC converter.
3. Insert the CD in the computer's CD-ROM drive.
4. The iQ_Monitor program may be run directly off the CD or it may be copied onto your computer's hard drive. To run the program off the CD, initiate the iQ_Monitor.exe file.
5. When the iQ_Monitor screen appears, the TX and RX indicators appear in the lower left corner of the status bar. A blinking TX indicates that the PC is transmitting commands to the receiver; a blinking RX indicates that the PC is receiving reports from the receiver. If either of these indicators stop blinking, there is no activity. The PC COM port settings appear in the lower right corner of this same status bar.
6. After a GPS antenna is connected to the receiver and the receiver has achieved a position fix, the transmitted position reports, time, velocity, satellites tracked, and GPS receiver status appear on the screen. The receiver also sends a health report every few seconds, even if satellites are not being tracked.

***Note** – If the iQ_Monitor program displays a question mark (?) in a data field, the receiver has not reported a status for this field. If a (?) remains in the data field, the GPS module may not be communicating with the computer. Re-check the interface cable connections and verify the serial port selection and settings. If the communication failure continues after checking all connections and settings, please call the Trimble Technical Assistance Center (TAC) at 1 (800) 767-4822.*

Hardware Integration

In this chapter:

- General Description
- Connectors
- Power Requirements
- Serial Interface
- Pulse-Per-Second (PPS)
- Mounting
- GPS Antennas

General Description

Trimble's new Lassen iQ GPS receiver adds complete GPS functionality to mobile products, in a postage-stamp-sized footprint with ultra-low power consumption. Using Trimble's breakthrough FirstGPS™ architecture, the module delivers complete position, velocity and time (PVT) solutions for use in mobile, battery-powered applications such as hand-held devices, PDAs, asset tracking devices, and navigation applications.

The Lassen iQ GPS module is packaged in a tiny form factor (26 mm x 26 mm x 6 mm, including the metal shield). It typically requires only less than 89 mW of power (at 3.3 VDC). The module includes flash memory for firmware upgrades and storing the user configuration.

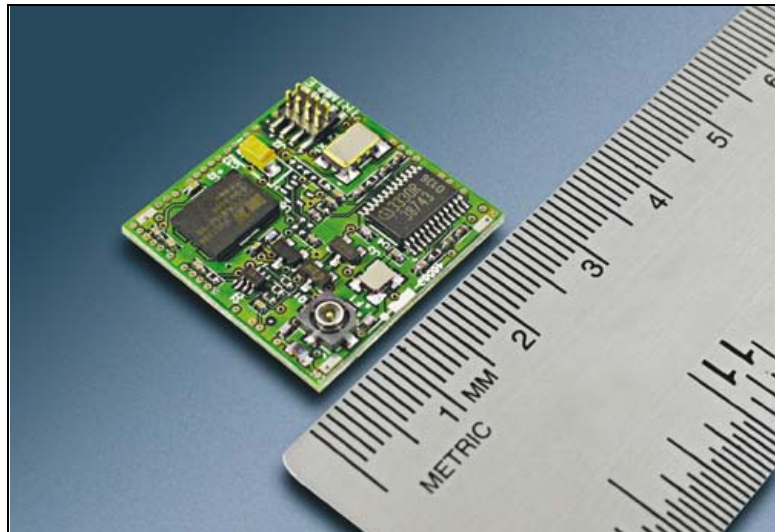

Figure 2.1 Lassen iQ GPS Receiver Board without Shield

Connectors

Digital IO/Power Connector

The Lassen iQ GPS module uses a single 8-pin (2x4) male header connector for both power and data I/O. The power and I/O connector, J2, is a surface mount micro terminal strip. This connector uses 0.09 inch (2.286mm) high pins on 0.05 inch (1.27mm) spacing. The manufacturer of this connector is Samtec, part number ASP 69533-01.

Note – See Appendix F for mechanical drawings and specifications.

Mating Connectors

The customer must supply his own mating connector to the Lassen iQ GPS receiver 8-pin (2x4) connector. There are two mating connectors available:

- Surface-Mount Mating Connector

A recommended surface mount mating connector is Samtec's part number CLP-104-02.

When a surface-mount mating connector is chosen, the RF connector must be attached to the Lassen iQ GPS module prior to securing the module to the user's PCB. The mounting tabs may be used for securing the Lassen iQ GPS module to the PCB when using the surface-mount mating scheme.

- Cable Strip Mating Connector

A low profile, cable strip mating connector is the second I/O mating method. A recommended cable strip part is Samtec's part number FFSD-04-?-XX part. The user will need to substitute the following letters and numbers into the part number when ordering this part where the '?' and 'XX' symbols occur: for the '?' symbol substitute the letter S for single end or D for double end; for the 'XX' symbol substitute the overall length in inches, $\pm 1/8$ inch, with a 2 inch minimum. Since the signals are CMOS TTL level signals, Trimble does not recommend cable lengths of longer than six inches.

If the cable strip I/O connector scheme is used, the connector side of the Lassen iQ GPS receiver will be facing up and the mounting tabs will be on the top of the module away from PCB. The RF connector is easily accessible, using this interfacing methodology.



Figure 2.2 Cable Strip Mating Connector

RF Connector

The RF connector mounted on the Lassen iQ GPS receiver is a Hirose connector, part number H.FL-R-SMT (10) 50 Ohm. The mating RF connector is Hirose H.FL-LP-XXX where XXX depends on the cable type.



Figure 2.3 Lassen iQ GPS Module with Connectors

Possible cable manufactures include the following:

- 1.48 mm diameter (single shield) cable:
 - CO-6F/FH-SB manufactured by Hitachi Cable Ltd.
 - UL1979 manufactured by Junkosha Co., Ltd.
 - 0.8DS-PBE manufactured by Sumitomo Electric Industry Co., Ltd.
- 1.32 mm diameter cable (double shield):
 - A12B0733 manufactured by Junkosha Co., Ltd.
- 1.47 mm diameter cable (single shield):
 - CXN2571 manufactured by W.L. Gore & Associated, Inc.

Trimble offers three antennas for use with the Lassen iQ GPS receiver receiver: The Ultra-Compact Embedded Antenna, which mates directly to the RF connector. The Compact Unpackaged Antenna and the Compact Magnetic-Mount Antenna, which mate through the optional RF transition cable to the module's RF connector. For more information on the antennas, see page 33.

Digital IO/Power Connector Pinout

The digital IO/Power connector pinout information is listed in Table 2.1.

Table 2.1 J2 I/O Connector Signals

Pin number	Function	Description
1	TXD A	Serial Port A transmit, 3.3 V TTL CMOS
2	GND	Ground, Power and Signal
3	RXD A	Serial Port A receive, 3.3 V TTL CMOS
4	PPS	Pulse-Per-Second, 3.3 V TTL CMOS
5	TXDB	Serial port B transmit, 3.3V TTL CMOS
6	RXDB	Serial port B receive, 3.3V TTL CMOS
7	Prime Power (VCC)	+3.3 VDC to ± 0.3 VDC
8	Battery Backup Power	+2.5 VDC to + 3.6 VDC

Power Requirements

The Lassen iQ GPS module requires +3.3 VDC \pm 0.3 VDC at 33 mA, typical excluding the antenna. The on-board capacitance is 10 μ F. An important design consideration for power is the module's internal clock frequency at 12.504 MHz \pm 3 KHz. Interference spurs on prime power in this narrow frequency band should be kept to less than 1mV.

The receiver does not require any special power up or down sequencing. The receiver power is supplied through pin 7 of the I/O connector. See Table 2.2 for the +3.3 VDC power specifications.

Warning – The Lassen iQ GPS receiver is ready to accept TSIP commands approximately 2.1 seconds after power -up. If a command is sent to the receiver within this 2.1 second window, the receiver will ignore the command. The Lassen iQ GPS receiver will not respond to commands sent within the 2.1 second window and will discard any associated command data.

Battery Back-up

The Lassen iQ GPS receiver provides an input for battery back-up (BBU) power to keep the module's RAM memory alive and to power the real-time clock when the receiver's prime power is turned off. RAM memory is used to store the GPS almanac, ephemeris, and last position. User configuration data, including port parameters and receiver processing options can be stored in non-volatile Flash which does not require back-up power. By using battery back-up, time to first fix in a hot start is reduced to 10 seconds (typical). Though not required, providing BBU power can reduce time to first fix. A 3.6 volt lithium battery used for back-up power can last up to three years.

Warning – If battery power is not present, the receiver’s power can be turned off and then back on to force a system reset and a cold start. The receiver should be off for no less than 3 minutes to ensure that the RAM memory does not retain any old data due to the residual voltage from the power supply. To avoid waiting the 3 minutes, turn the receiver unit back on immediately and issue TSIP command 0x1E with the value 4B. This packet forces a cold start and clears battery backed RAM.

Note – 2.5V is the minimum allowable battery back-up voltage. When the battery back-up power output drops below 2.5V, the real-time clock may not operate over the specified temperature range. This can also significantly extend the time to first fix. Trimble does not recommend the use of Super Caps as battery back-up.

Table 2.2 Power Requirements

Signal	Voltage	Current	J2 Pin #
VCC	3.0 to 3.6	27 mA	7
Battery Back-up	2.5 to 3.6	20µA (at 3.3 volts, +25°C)	8
Ground	0	--	2

Note – For proper operation when using battery back-up, the voltage value of the battery should be 10% less than the value of the VCC.

Serial Interface

As an embedded design, the Lassen iQ GPS module provides direct CMOS compatible TTL level serial I/O. The RX and TX signals on the J2 I/O connector are driven directly by the DUART on the Lassen iQ GPS receiver. Interfacing these signals directly to a UART in your application circuitry provides direct serial communication without the complication of RS-232 or RS-422 line drivers.

Note – The serial I/O signals on J2 are TTL level. They are not inverted or driven to RS-232 levels.

Serial Port Connections

Below are the required connections for the Lassen iQ GPS Rx pins when they are not used for communication. This is required for firmware release 1.10 and recommended for all subsequent firmware releases.

Table 2.3 Serial Port Connections for Rx Pins

Serial Port	Pin #	Assignment	Default	Required Connections
1	Pin 3	RxA	TSIP-IN	High (VCC) (via pullup)
2	Pin 6	RxB	RTCM-IN	High (VCC) (via pullup)

Below are the allowable connections for the Lassen iQ GPS Tx pins when the pins are not used for communication. This configuration applies to all firmware versions.

Table 2.4 Serial Port Connections for Tx Pins

Serial Port	Pin #	Assignment	Default	Allowable Connections
1	Pin 1	TxA	TSIP-OUT	Floating or High (VCC) (via pullup)
2	Pin 5	TxB	NMEA-OUT	Floating or High (VCC) (via pullup)

***Note** – Attaching the Tx lines (pins 1 and 5) to VCC and using pullup resistors is not required. Use of pullup resistors and attaching to VCC on Rx lines (pins 3 and 6) is mandatory (for firmware release 1.10 and recommended for subsequent firmware releases) if these pins are not otherwise connected to the system’s communication ports.*

Below are the failure modes that will be experienced if the Lassen iQ GPS pins are not connected as recommended (see above).

Table 2.5 Serial Port Connections for Tx and Rx Pins

Pin #	High (VCC)	Low (GND)	Floating
Pin 1 (TxA, SI01)	Works	Board will be damaged	Works
Pin 3 RxA, SI01	Works	Will never produce a position fix	Do not choose this option for firmware release 1.10. Operation cannot be guaranteed. Failure mode: will never produce a position fix
Pin 5 (TxB, SI02)	Works	Board will be damaged	Works
Pin 6 RxB, SI02	Works	Do not choose this option! Operation cannot be guaranteed. Failure modes: may never produce a position fix, may output potentially bad fixes intermittently	Do not choose this option for firmware release 1.10. Operation cannot be guaranteed. Failure modes: may never produce a position fix, may output potentially bad fixes intermittently

***Note** – The table above indicates that the Tx pins 1 and 5 should not be tied to Ground. As there are no internal pullups or current limiting resistors, tying Tx to Ground will directly pull down the VCC rail through the chip. This will pull excessive current, stressing the chip beyond specification until it eventually fails.*

Pullup Resistor

A pullup resistor should be added to the board in the range of 1K to 100K ohms for connecting the above-mentioned pins to VCC. One end of the pullup resistor is connected to the iQ pin and the other end is connected to the positive supply voltage VCC.

Note – The pullup resistor does not have to be powered by VCC. A separate power source can be used, as long as it is not greater than VCC. The minimum power for the pullup is 2.0V.

Resistor Impact on PCB Power Consumption

The pullups do not affect the Lassen iQ GPS power consumption since the resistors will be external to the board. The overall power consumption of the user's PCB will increase slightly. Assuming 3.3V VCC and 100k-pullup resistor, the power consumption increase will be 109uW or 33uA per pullup. With a 1k pullup resistor, the power consumption increase will be 10.9mW or 3.3mA per pullup.

To reduce the current draw, the users can choose higher value pullup resistors in the allowable resistor range of 1K-100K ohms. To minimize the overall power consumption of the user's board, 100K ohms pullup can be selected.

To keep BOM items to a minimum, the user can choose the highest value resistor used on their board.

Pulse-Per-Second (PPS)

The Lassen iQ GPS receiver provides a four microsecond wide, CMOS compatible TTL level Pulse-Per-Second (PPS). The PPS is a positive pulse available on pin 4 of the power and I/O connector. The rising edge of the PPS pulse is synchronized with respect to UTC. The timing accuracy is ± 50 nanoseconds when valid position fixes are being reported.

The rising edge of the pulse is typically less than 20 nanoseconds. The distributed impedance of the attached signal line and input circuit can affect the pulse shape and rise time. In early PPS mode, the PPS can drive a load up to 5mA without damaging the module. The falling edge of the pulse should not be used. In its default mode PPS is always on (early PPS) and is driven by the Real Time Clock (RTC) until the receiver acquires GPS time from the satellite and is getting fixes. In early PPS mode, the PPS is output immediately after main power is applied, and continues even if the receiver loses GPS lock. The drift of the PPS, when the Lassen iQ GPS receiver is not tracking satellites, is unspecified and should not be used for synchronization.

The PPS output modes can be controlled with TSIP packet 0x35. The modes are Always on (default), Fix Based, or Always Off. Cable delay compensation is available through the use of TSIP packet 0x8E-4A. After a specific mode is selected, it can be stored in non-volatile memory (FLASH) using TSIP command 0x8E-26. For more information, see Appendix A.

***Note** – Trimble Navigation has measured better than 50 nanoseconds accuracy on the Lassen iQ GPS receiver PPS signal in static mode. For more information on the use of the Lassen iQ GPS module in timing applications, contact your Trimble sales representative.*

Mounting

The Lassen iQ GPS PCB is encased in a metal enclosure. The enclosure acts as a protective case. There are four mounting solder tabs on the bottom of the enclosure. When the surface-mount mating connector is used, the mounting tabs may be used for securing the Lassen iQ GPS module on the user's PCB. When the cable strip I/O connector scheme is used, the connector side of the Lassen iQ GPS module will be faced up and the mounting tabs will be on the top of the module away from PCB.

The Lassen iQ GPS module can be attached to the integrator platform by many methodologies including solder, glue, double sided adhesive tape, and custom hold down mounts for the module's mounting tabs.

***Note** – See Appendix F for mechanical drawings and specifications regarding the spacing of the mounting tabs and the dimensions of the enclosure.*

GPS Antennas

The antenna receives the GPS satellite signals and passes them to the receiver. The GPS signals are spread spectrum signals in the 1575 MHz range and do not penetrate conductive or opaque surfaces. Therefore, the antenna must be located outdoors with a clear view of the sky. The Lassen iQ GPS receiver requires an *active* antenna. The received GPS signals are approximately -130 dBm, at the surface of the earth (in typical environments). Trimble's active antennas include a preamplifier that filters and amplifies the GPS signals before delivery to the receiver.

Trimble offers three antennas for use with the Lassen iQ GPS receiver described below and in Appendix D.

1. The Ultra-Compact Embedded GPS Antenna with an HFL connector, is ideal for portable and mobile applications. This unpackaged antenna is approximately the same size as the module itself, and can be easily integrated into mobile applications. This antenna is supplied with the Starter Kit (see Figure 2.4).
2. A Compact Unpackaged Antenna with an MCX connector, slightly larger than the ultra-compact model (see #1 above), mates to the Hirose connector on the Lassen iQ GPS module with an optional RF transition cable (see Figure 2.5).

3. A Compact Magnetic-Mount GPS Antenna with a 5 m cable and an MCX or SMA connector. This antenna provides for a flexible, movable installation. The MCX or SMA output connector mates to the Hirose connector on the Lassen iQ GPS module with an optional RF transition cable. The antenna with the MCX connector is supplied with the Starter Kit (see Figure 2.6). The MCX connector on the end of the antenna cable mates to the MCX connector in the front of the Starter Kit interface unit. The two screw holes on the bottom of the antenna can be used to mount the antenna to a metal plate. The dimensions of these holes are 2.06 mm in diameter and 5mm in depth.

Warning – When magnetic-mount or permanent-mount GPS antennas are installed on a metal surface for prolonged periods, care must be taken to insulate the antennas in order to prevent galvanic corrosion.

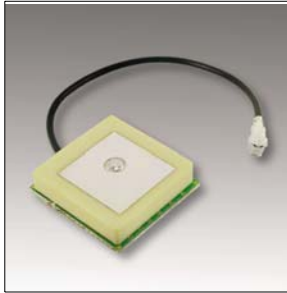

Figure 2.4 Ultra-Compact Embedded GPS Antenna



Figure 2.5 Compact Unpackaged GPS Antenna



Figure 2.6 Compact Magnetic-Mount GPS Antenna

Software Interface

In this chapter:

- Start-up
- Communicating with the Lassen iQ GPS Receiver
- Port Protocol and Data Output Options
- Custom Port Configuration
- When prompted, select the factory default option.

Start-up

Lassen iQ GPS receiver module is a complete 12-channel parallel tracking GPS receiver designed to operate with the L1 frequency, standard position service, Coarse Acquisition code. When connected to an external GPS antenna, the receiver contains all the circuitry necessary to automatically acquire GPS satellite signals, track up to 12 GPS satellites, and compute location, speed, heading, and time. The receiver will automatically begin to search for and track GPS satellite signals at power-up.

The performance of a GPS receiver at power-on is determined largely by the availability and accuracy of the satellite ephemeris data and the availability of a GPS system almanac.

The first time the receiver is powered-up, it is searching for satellites from a cold start (no almanac). While the receiver will begin to compute position solutions within the first two minutes, the receiver must continuously track satellites for approximately 15 minutes to download a complete almanac. This initialization process should not be interrupted. With a complete almanac and back-up power, the time to first fix can typically be shortened to less than 42 seconds. The receiver will respond to commands almost immediately after power-up (see Warning below).

Note – See Chapter 4 for further detail on ephemeris data and the GPS almanac.

Warning – The Lassen iQ GPS Receiver is ready to accept TSIP commands approximately 2.1 seconds after power -up. If a command is sent to the receiver within this 2.1 second window, the receiver will ignore the command. The Lassen iQ GPS Receiver will not respond to commands sent within the 2.1 second window and will discard any associated command data.

Communicating with the Lassen iQ GPS Receiver

The Lassen iQ GPS Receiver supports three message protocols: TSIP, TAIP, and NMEA. Communication with the module is through two CMOS compatible, TTL level serial ports. The port characteristics can be modified to accommodate your application requirements. Port parameters can be stored in non-volatile memory (FLASH) which does not require backup power. Table 3.1. lists the default port characteristics.

Software Tools

The Software Tools provided on the Starter Kit CD-ROM include both user friendly Windows and DOS applications to facilitate communication with the receiver, via the Trimble Standard Interface Protocol (TSIP). This CD also includes sample C source code and reusable routines to aid in developing applications.

Note – The TSIP, TAIP, and NMEA protocols are discussed beginning on page 42 of this chapter, and in the Appendices of this document.

Port Configuration

The Lassen iQ GPS receiver module has two I/O ports. Table 3.1 provides the default protocols and port configurations for the receiver, as delivered from the factory. TSIP IN/OUT is the default protocol on Port 1 and RTCM-IN and NMEA-OUT is the default protocol on Port 2.

Table 3.1 Default Protocols and Port Configurations

Port	Input Protocol	Default Setup	Output Language	Default Setup
1	TSIP	Baud Rate: 9600 Data Bits: 8 Parity: Odd Stop Bits: 1 No Flow Control	TSIP	Baud Rate: 9600 Data Bits: 8 Parity: Odd Stop Bits: 1 No Flow Control
2	RTCM	Baud Rate: 4800 Data Bits: 8 Parity: None Stop Bits: 1 No Flow Control	NMEA	Baud Rate: 4800 Data Bits: 8 Parity: None Stop Bits: 1 No Flow Control

The Lassen iQ GPS Receiver can also be configured to output TAIP messages. The Trimble standard port characteristics for TAIP are:

- Baud Rate: 4800
- Data Bits: 8
- Parity: None
- Stop Bits: 1
- No Flow Control

Any standard serial communications program, such as Windows Hyper-Terminal or PROCOMM, can be used to view the NMEA or TAIP output messages. TSIP is a binary protocol and outputs raw binary serial data that cannot be read when using Windows Terminal or PROCOMM. To view the output of the TSIP protocol in text format, use the iQ_CHAT or the iQ_Monitor program (see the CD-ROM provided in the Starter Kit).

The serial port driver in the iQ_CHAT Tool Kit matches the Lassen iQ GPS receiver serial port characteristics. The TSIPPRNT program converts binary data logged with the iQ_CHAT program into text that may be printed and displayed. Both of these tools are included in the Software Developer's Toolkit.

Warning – When using the TSIP protocol to change port assignments or settings, confirm that your changes do not affect the ability to communicate with the receiver (e.g., selecting the PC COM port settings that do not match the receiver's, or changing the output protocol to TSIP while not using iQ_CHAT).

Port Protocol and Data Output Options

Protocol Configuration and Interface

The factory default I/O protocol for Port 1 of the Lassen iQ GPS receiver is the Trimble Standard Interface Protocol (TSIP) for both input and output. The settings for Port 1 are 9600 baud 8-odd-1. The factory default protocol for Port 2 is RTCM-IN and NMEA-OUT. The settings for Port 2 are 4800 baud 8-none-1. The receiver protocol can be re-configured using TSIP command packet 0xBC, in conjunction with iQ_CHAT, iQ_Monitor, or a user written serial interface program. See Appendix A for details on the 0xBC command packet.

iQ_CHAT provides the simplest means to communicate with the receiver using a PC (386 or higher) running either the DOS or Windows operating systems. Responses are displayed on the computer monitor in text format.

iQ_Monitor, a Windows-based GUI, provides a versatile graphical interface for monitoring TSIP data. This application allows the user to view complete receiver operations including data output, status and configuration. In this application, the entry of command packets is replaced by traditional point and click pull-down menus.

C source code routines for iQ_CHAT are also provided on the CD contained in the Starter Kit. When used as software design templates, this source code can significantly speed-up code development.

The protocol settings and options are stored in battery-backed Random-Access-Memory (BBRAM). They can also be saved into the non-volatile memory (Flash), if desired, using command 0x8E-26. See to Appendix A for additional information on Flash storage for custom operation.

TSIP Data Output Modes

TSIP is the default protocol for Port 1 on the Lassen iQ GPS receiver. This binary language offers users a wide variety of commands and reports. TSIP enables the Lassen iQ GPS receiver to operate in two data output modes, both available during operation. In Query Mode, packet data is returned in response to input query packets. In Automatic Mode, a selected group of data packets is output continuously at two fixed rates – every second and every five seconds. The format and ensemble of the automatic output packets is configured using packets 0x35, 0x70, and 0x8E-20 (see Appendix A for packet details). Packet settings are stored in BBRAM. They can also be saved in non-volatile memory (Flash) using command packet 0x8E-26. See Appendix A for additional information on Flash storage for custom operation.

Default TSIP Output Settings

Default 0x35 setting (byte 0=2, 1= 2, 2=0, 3=0):

- Position and velocity data precision: single precision floating point
- Position output option and format (byte 0 setting):
 - Latitude – radian
 - Longitude – radian
 - Altitude – meters (WGS-84)
- No super-packet output
- Velocity output option and format:
 - East Velocity – meters/sec.; + for East
 - North Velocity – meters/sec.; + for North
 - Up Velocity – meters/sec.; + for Up
- Timing
 - GPS Time Output
 - PPS Always ON
- Auxiliary/Pseudo Range Measurement
 - Raw Measurements OFF
 - Raw Pseudo Ranges OFF
 - Output AMU values

Default 0x70 setting (byte 0=1, 1=1. 2=1. 3=0):

- Position-Velocity Dynamic Filter enabled
- Position-Velocity static Filter enabled
- Altitude Filter enabled

Default 0x8E-20 setting (byte 1 = 1):

- 0x8F-20 output is included in the super-packet for automatic output
IF packet 0x35 selects the super-packet for automatic output options

Automatic TSIP Output Packets (fixed rate)

One second interval:

- 0x4A – (1) GPS position fix; (2) clock bias and time of fix; {20 byte format}
- 0x56 – velocity fix
- 0x6D – (1) list of satellites used for position fixes; (2) PDOP, HDOP, VDOP; (3) fix mode
- 0x82 – DGPS position fix mode

Five second interval:

- 0x41 – (1) GPS time of the week (seconds); (2) extended GPS week number; (3) GPS UTC offset (seconds)
- 0x46 – health of receiver
- 0x4B – (1) Machine/Code ID; (2) Real-time-clock availability status; (3) almanac validity status; (4) having super-packet support status

Packet Output Order

After power up or a software reset (packet 0x1E), seven start-up packets are sent, only once, by the receiver in this order: 45, 46, 4B, 4A, 56, 41, 82

Before position fixes are available, the 1 second and 5 second interval packets are sent in this order, periodically:

- Every one second for 5 seconds: 6D, 82
- Every five seconds 41, 46, 4B

When position fixes are available, the 1 second and 5 second interval packets are sent in this order, periodically:

- Every one second for 4 seconds: 4A, 56, 6D, 82
- Every 5 seconds: 4A, 56, 41, 46, 4B, 6D, 82

NMEA 0183 Protocol and Data Output Options

The National Marine Electronics Association (NMEA) protocol is an industry standard data protocol which was developed for the marine industry. Trimble has chosen to adhere stringently to the NMEA 0183 data specification as published by the NMEA. The Lassen iQ GPS receiver also adheres to the NMEA 0183, Version 3.0 specification.

NMEA data is output in standard ASCII sentence formats. Message identifiers are used to signify what data is contained in each sentence. Data fields are separated by commas within the NMEA sentence. In the Lassen iQ GPS receiver, NMEA is an output only protocol. The NMEA protocol is described in detail in Appendix E.

The receiver is shipped from the factory with the TSIP protocol configured on Port 1 and RTCM-IN/NMEA-OUT on Port 2. The Port 2 characteristics conform to the NMEA industry standard:

- 4800 baud
- 8 data bits
- No parity
- 1 stop bit
- No flow control

The receiver can be reconfigured using TSIP command packet 0xBC, in conjunction with iQ_CHAT, iQ_Monitor, or a user written serial interface program.

The NMEA output messages selection and message output rate can be set using TSIP command packet 0x7A. The default setting on Port 2 is to output the GGA and VTG messages at a 1 second interval.

If the NMEA configuration is permanently changed for the application, the protocol configuration (0xBC) and NMEA message output setting (0x7A) can be stored in the non-volatile memory (on-board FLASH) using TSIP command 0x8E-26.

Custom Port Configuration

iQ_CHAT can be used to customize the Lassen iQ GPS receiver configuration settings and to save a configuration to non-volatile memory. The most recent port configuration is stored in BBRAM. This eliminates the need to repeat setup each time the receiver power is cycled. However, if the battery-backed power is accidentally lost, the port configuration automatically resets to either what was saved in the non-volatile memory (FLASH) or to the factory default.

Tip – To ensure continuous operation, store all port configuration changes in the non-volatile memory.

Following are step-by-step instructions for using iQ_CHAT to customize Lassen iQ GPS receiver port configuration.

Customizing the Configuration

1. Insert the CD in the CD-ROM drive of your computer.
2. Open a DOS window and set the path to the iQ_CHAT location.
3. To run the program, type `iQ_CHAT -c1` if attached to PC COM1, or type `iQ_CHAT -c2` if attached to PC COM2.
4. Power-up the receiver. Automatic report streams should be scrolling up in the DOS window. Assuming that your receiver is set to the default configuration, the settings will be: 9600 baud, 8-odd-1.

Note – If data is not being output after receiver power up, use the “^” command in iQ_CHAT to reset the COM1/COM2 setting in PC (not the receiver).

Tip – Entering “?” in the iQ_CHAT window displays all the available commands and their corresponding TSIP packets.

5. To re-configure the port settings and protocol, type “U” and respond to the input prompts. At the end of this procedure, select the option that resets the PC COM port to match the new settings. Communication should resume almost immediately.

Saving the Configuration

1. Before storing the new configuration in FLASH, confirm that the receiver has been configured to the desired settings.

Warning – Record the new serial port settings. If power is lost, this will speed-up recovery. Alternatively, the receiver can always be returned to the default configuration.

2. To save the configuration to Flash:
 - Enter “=” to access the command list page for the 0x8E command packet.
 - Enter “s”, to send the 0x8E-26 command packet.
 - Communication is momentarily suspended while the configuration is being stored in Flash.
3. To confirm that the configuration changes have been saved, turn-off the power supply and the battery back-up for a few minutes. Then, power-up the receiver and confirm that the configuration changes have been retained. Alternatively, you can use Packet 1E to command a cold start.

***Note** – Command packet 0x8E-26 executes storage of various types of receiver settings in addition to the port and protocol. See Table 3.2 for a complete list of the settings that can be stored in FLASH memory.*

Returning to the Factory Settings

At any time, the receiver can be returned to the factory default configuration, using command packet 0x1E.

1. Type “^k” to invoke the 0x1E command.
2. When prompted, select the factory default option.

**Table 3.2 iQ_CHAT Command Settings Stored in Flash Memory
Command Packet 0x8E-26**

TSIP Command ID	iQ_CHAT Keystroke	Description	TSIP Response ID
0x35	'O'	TSIP input/output formatting <ul style="list-style-type: none"> – Superpacket output (on/off) – Position format (LLA and/or ECEF) – Precision (double or single) – altitude format (MSL or HAE) – Timetag format (GPS or UTC) – PPS modes – SNR format (AMU or C/N₀) – Automatic pseudorange output 	0x55
0x69	'e'	Enhanced Sensitivity Mode Control	0x89
0x70	'l'	Position filter controls <ul style="list-style-type: none"> – Position filter on/off – Static filter on/off – Altitude filter on/off 	0x70
0x7A	'q'	NMEA message formats and schedule <ul style="list-style-type: none"> – NMEA output messages – NMEA output interval 	0x7B
0x7e	'a'	TAIP message formats and schedules	0x7F

**Table 3.2 iQ_CHAT Command Settings Stored in Flash Memory
Command Packet 0x8E-26 (Continued)**

TSIP Command ID	iQ_CHAT Keystroke	Description	TSIP Response ID
0xBB	'p'	GPS configuration parameters <ul style="list-style-type: none">– Operating dimension (2D, 3D,...)– DGPS mode– Dynamics mode– Elevation mask– SNR mask– DOP mask– PDOP switch– DGPS correction age	0xBB
0xBC	'U'	Serial port configuration <ul style="list-style-type: none">– Protocol: input, output– Baud, data bits, parity, stop bits	0xBC
0x8E-20	'= g'	Fixed point superfix control (default = on)	0x8F-20

Timing Applications

The Lassen iQ GPS receiver is an excellent source for accurate system timing. Two examples of applications requiring accurate time are environmental data acquisition and synchronization of communications networks. The timing functions of the receiver are supported by the TSIP protocol and the PPS signal. See Report Packet 0x41 or Super Packet 0x8F-20 in Appendix A for a description of the time function reports for TSIP.

Note – GPS time differs from UTC (Universal Coordinated Time) by a variable integer number of seconds: $UTC = (GPS\ time) - (GPS\ UTC\ Offset)$

As of April 2002, the GPS UTC offset was 13 seconds. The offset increases by 1 second approximately every 18 months. System designers should plan to read the offset value as a part of the timing interface to obtain UTC. The GPS week number is in reference to a base week (Week #0), starting January 6, 1980.

The current GPS UTC offset is contained within the almanac transmitted by the GPS system. The Lassen iQ GPS Receiver must have a complete almanac before the offset data is valid.

Note – As of January 2005, the GPS Control Organization has not added leap seconds on the usual 18 month schedule. As a result, the offset has remained at 13 seconds.

Extended GPS Week Number

The Lassen iQ GPS Receiver outputs the Extended GPS Week Number as the absolute number of weeks since the beginning of GPS time or January 6, 1980. If the true GPS Week Number is desired, ignore the extra MSBs of the Extended GPS Week Number and use only the 10 LSBs (bytes 4 and 5 of Packet 0x41).

Note – After week number 2331, in year 2024, the TSIP week number rolls back to 1308. All dates reported in NMEA and TAIP, will be invalid.

Known Anomalies in Firmware Release 1.10

The following are know anomalies found in Lassen iQ FW v1.10. These anomalies will be fixed in all follow on versions:

- **Position outages during the Weekend Rollover**
The receiver would experience satellites being dropped and thus several seconds of position outages during the weekend rollover, which happens during Saturday to Sunday at midnight each week. This anomaly is found in Lassen iQ GPS receiver firmware version 1.10 and will be fixed in all future firmware releases.
- **Position outages during WNRO (Week Number Rollover)**
The receiver would experience satellites being dropped and thus several seconds of position outages during the next week number rollover, which will happen on April 7, 2019 (GPS time). This problem is caused by the End-Of-the-Week Rollover problem as End-Of-the-Week Rollover occurs during WNRO. This anomaly is found in Lassen iQ GPS receiver firmware version 1.10 and will be fixed in all future firmer releases.
- **Extended TTFB times in year 2023 - 2024**
The user would experience extended warm and hot startup times between years 2023 to 2024. This anomaly is found in the Lassen iQ GPS receiver firmware version 1.10 and will be fixed in all future firmware releases.
- **Static Filter issue**
The static filter can be turned and stay on/off, based on user configuration or by TSIP packet 0x70. However, when it is set to off, it will be turned on internally after 255 position fixes are generated. The query on the status of the static filter would still indicate that it is being turned off even though it has been turned on internally. This anomaly is found in Lassen iQ GPS receiver firmware version 1.10 and will be fixed in all future firmer releases.
- **TSIP packet 0x65 is not functional in Lassen iQ GPS receiver FW v1.10.** It will be fixed in all future firmware releases.

Operation and Performance

In this chapter:

- Introduction
- GPS Satellite Message
- Satellite Acquisition and Time to First Fix
- Satellite Mask Settings
- Standard Operating Modes
- Position Accuracy
- Coordinate Systems
- Performance Characteristics
- Lassen iQ GPS Receiver Sensitivity Modes
- Lassen iQ GPS Receiver Aided GPS Feature
- GPS Timing
- System Architecture

Introduction

This chapter describes the Lassen iQ GPS receiver satellite acquisition and tracking processes, performance characteristics, and system architecture. This discussion assumes that you are familiar with the basic theory of the Global Positioning System. Before proceeding to the detailed discussion of the satellite acquisition and tracking process, please review the GPS satellite message description on the next page.

The Lassen iQ GPS receiver satellite acquisition and tracking algorithms can achieve a position solution without any initialization. The receiver automatically selects and tracks the best combination of satellites to compute position and velocity. As satellites move out of view, the Lassen iQ GPS receiver automatically acquires new satellites and includes them in the solution set as required.

GPS Satellite Message

Every GPS satellite transmits the Coarse/Acquisition (C/A) code and satellite data modulated onto the L1 carrier frequency (1575.42 MHz). The satellite data transmitted by each satellite includes a satellite almanac for the entire GPS system, its own satellite ephemeris and its own clock correction.

The satellite data is transmitted in 30-second frames. Each frame contains the clock correction and ephemeris for that specific satellite, and two pages of the 50-page GPS system almanac. The almanac is repeated every 12.5 minutes. The ephemeris is repeated every 30 seconds.

The system almanac contains information about each of the satellites in the constellation, ionospheric data, and special system messages. The GPS system almanac is updated weekly and is typically valid for months. The ephemeris contains detailed orbital information for a specific satellite. Ephemeris data changes hourly, but is valid for up to four hours. The GPS control segment updates the system almanac weekly and the ephemeris hourly through three ground-based control stations. During normal operation, the Lassen iQ GPS receiver module updates its ephemeris and almanac as needed.

The performance of a GPS receiver at power-on is determined largely by the availability and accuracy of the satellite ephemeris data and the availability of a GPS system almanac.

Satellite Acquisition and Time to First Fix

Cold-Start

The term “cold-start” describes the performance of a GPS receiver at power-on when no navigation data is available. “cold” signifies that the receiver does not have a current almanac, satellite ephemeris, initial position, or time. The cold-start search algorithm applies to a Lassen iQ GPS receiver which has no memory of its previous session (i.e., is powered on without the memory backup circuit connected to a source of DC power). This is the “out of the box” condition of the GPS module as received from the factory.

In a cold-start condition the receiver automatically selects a set of eight satellites and dedicates an individual tracking channel to each satellite, to search the Doppler range frequency for each satellite in the set. If none of the eight selected satellites is acquired after a pre-determined period of time (time-out), the receiver will select a new search set of eight satellites and will repeat the process, until the first satellite is acquired. As satellites are acquired, the receiver automatically collects ephemeris and almanac data. The Lassen iQ GPS receiver uses the knowledge gained from acquiring a specific satellite to eliminate other satellites, those below the horizon, from the search set. This strategy speeds the acquisition of additional satellites required to achieve the first position fix.

The cold-start search sets are established to ensure that at least three satellites are acquired within the first two time-out periods. As soon as three satellites are found, the receiver will compute an initial position fix. The typical time to first fix is less than 2 minutes.

A complete system almanac is not required to achieve a first position fix. However, the availability and accuracy of the satellite ephemeris data and the availability of a GPS almanac can substantially shorten the time to first fix.

Warm Start

In a warm-start condition the receiver has been powered down for at least one hour but has stored a current almanac, an initial position, and time, in memory.

When connected to an external back-up power source (battery back-up), the Lassen iQ GPS receiver retains the almanac, approximate position, and time to aid in satellite acquisition and reduce the time to first fix. When an external back-up battery is not used, the TSIP protocol allows the almanac, an initial position, and time to be uploaded to the receiver via the serial port, to initiate a warm start.

During a warm start, the Lassen iQ GPS receiver identifies the satellites which are expected to be in view, given the system almanac, the initial position and the approximate time. The receiver calculates the elevation and expected Doppler shift for each satellite in this expected set and directs the eight tracking channels in a parallel search for these satellites.

The warm start time to first fix, when the receiver has been powered down for more than 60 minutes (i.e. the ephemeris data is old), is usually less than 45 seconds.

Hot Start

A hot start strategy applies when the Lassen iQ GPS receiver has been powered down for less than 60 minutes, and the almanac, position, ephemeris, and time are valid. The hot start search strategy is similar to a warm start, but since the ephemeris data in memory is considered current and valid, the acquisition time is typically less than 20 seconds.

Garage Search Strategy

During a warm start search, the Lassen iQ GPS receiver knows which satellites to search for, based on the system almanac, the initial position (last known position) and the current time. In some cases, the receiver may not be able to acquire the expected satellite signals (e.g., a vehicle parked in a garage or a vessel in a covered berth). Trimble's patented "garage search" strategy, also known as a split search, is designed for such situations.

If the receiver does not acquire the expected set of satellites within 5 minutes of power-on, some of the eight tracking channels will continue to search for the expected satellites (warm search) while the remaining channels are directed in a cold start search. This strategy minimizes the time to first fix in cases where the stored almanac, position and time are invalid. The stored information is flushed from memory, if the cold start search proves effective and the warm search fails.

System Reset

The Lassen iQ GPS receiver can be reset with software commands or by cycling power. A system reset will cause the receiver to restart and begin the satellite acquisition and tracking process again. There are three types of system resets: soft reset, hard reset, and factory reset. The TSIP protocol supports all three resets using the 0x1E command. Power cycling can be used for either the soft reset or the hard reset.

A soft reset is a system restart. In a soft reset, the system will attempt to acquire satellites using the satellite information and last position data stored in RAM, and the time information supplied by the real-time clock. There are two ways to initiate a soft reset:

- Cycling main power while keeping the memory and the real-time clock alive with back-up power.
- Issuing Command Packet 0x25.

A soft reset is the same as a warm or hot start, if the information contained in memory and supplied by the real-time clock is valid.

A hard reset is a system restart that results in satellite acquisition search using a default search set. Any data contained within RAM memory is discarded and the real-time clock is re-initialized. Even if back-up power is supplied, the information from memory and the real-time clock is not used. There are two ways to initiate a soft reset:

- Issuing the 0x1E command with a value of 0x4B.
- Cycling power without back-up power applied. Using this method, power must be removed for at least 3 minutes to ensure any residual memory storage is erased. If power is cycled rapidly, the 0x1E command with a value of 0x4B must then be issued to the receiver 2.5 seconds after power is restored to ensure a hard reset.

A factory reset is used to restore all the factory default settings into the receiver. Any user settings stored in Flash memory will be erased. Issuing the 0x1E command with a value of 0x46 will initiate a factory reset.

Satellite Mask Settings

Once the Lassen iQ GPS receiver has acquired and locked onto a set of satellites, which pass the mask criteria listed in this section, and has obtained a valid ephemeris for each satellite, it will output regular position, velocity and time reports according to the protocol selected.

The default satellite masks observed by the Lassen iQ GPS receiver are listed in Table 1. These masks serve as the screening criteria for satellites used in fix computations and ensure that position solutions meet a minimum level of accuracy. The Lassen iQ GPS receiver will only output position, course, speed and time when a satellite set can be acquired which meets all of the mask criteria. The satellite masks can be adjusted in GPS receivers accepting the TSIP protocol. (See Appendix A for details on key setup parameters.)

Table 4.1 **Satellite Mask Settings**

Mask	Setting
Elevation	5°
SNR	2
PDOP	12
PDOP Switch	6

Elevation Mask

Satellites below a 5° elevation are not used in the position solution. Although low elevation satellites can contribute to a lower/better PDOP, the signals from low elevation satellites are poorer quality, since they suffer greater tropospheric and ionospheric distortion than the signals from higher elevation satellites. These signals travel further through the ionospheric and tropospheric layers.

In addition, low elevation satellites can contribute to frequent constellation switches, since the signals from these satellites are more easily obscured by buildings and terrain. Constellation switches can cause noticeable jumps in the position output. Since worldwide GPS satellite coverage is generally excellent, it is not usually necessary to use satellites below a 5° elevation to improve GPS coverage time. In some applications, like urban environments, a higher mask may be warranted to minimize the frequency of constellation switches and the impact of reflected signals.

SNR Mask

Although the Lassen iQ GPS receiver is capable of tracking signals with SNRs as low as 0, the default SNR mask in Standard Sensitivity Mode is set to 2 to eliminate poor quality signals from the fix computation and minimize constellation switching. Low SNR values may result from:

- Low Elevation Satellites
- Partially Obscured Signals (e.g. Dense Foliage)
- Multi-Reflected Signals (Multi-Path)

The distortion of signals and the frequent constellation switches associated with low-elevation satellites were discussed above. In mobile applications, the attenuation of signals by foliage is typically a temporary condition. Since the Lassen iQ GPS receiver can maintain lock on signals with SNRs as low as 0, it offers excellent performance when traveling through heavy foliage.

Multi-reflected signals, also known as Multi-path, can degrade the position solution. Multi-path is most commonly found in urban environments with many tall buildings and a preponderance of mirrored glass, which is popular in modern architecture. Multi-reflected signals tend to be weak (low SNR value), since each reflection attenuates the signal. By setting the SNR mask to 3 or higher, the impact of multi-reflected signals is minimized.

DOP Mask

Position Dilution of Precision (DOP) is a measure of the error caused by the geometric relationship of the satellites used in the position solution. Satellite sets which are tightly clustered or aligned in the sky will have a high DOP and will contribute to a lower position accuracy. For most applications, a DOP mask of 12 offers a satisfactory trade-off between accuracy and GPS coverage time. With world-wide GPS coverage now available, the DOP mask can be lowered even further for many applications without sacrificing coverage.

PDOP Switch

The default positioning mode for the Lassen iQ GPS receiver is Automatic. In this mode, the receiver attempts to generate a 3-dimensional (3D) position solution, when four or more satellites meeting the mask criteria are visible. If such a satellite set cannot be found, the receiver will automatically switch to 2-dimensional (2D) mode. The PDOP switch establishes the trade-off between 3D positioning and PDOP. With the PDOP Switch set to 6, the receiver will compute a 2D position with a HDOP below 6 rather than a 3D position with a PDOP greater than 6, even when four or more satellites are visible.

Note – PDOP Switch is only used in Auto mode.

Standard Operating Modes

The tracking mode controls the allocation of the receiver's tracking channels and the method used for computing position fixes.

Fix Modes

The Lassen iQ GPS receiver offers three positioning modes: 2D Manual, 3D Manual, and Automatic 2D/3D. Automatic 2D/3D is the default mode for the Lassen iQ GPS receiver. The positioning mode can be modified in receivers accepting TSIP commands. (See Appendix A for more information on the TSIP protocol.)

2D Manual

In 2D Manual mode, the Lassen iQ GPS receiver will only generate 2-dimensional (2D) position solutions (latitude and longitude only), regardless of the number of visible satellites. If the altitude is not entered, the receiver uses zero as the default altitude. The greater the deviation between the actual and default altitudes, the greater the error in the 2D position. For TSIP applications, enter local altitude in MSL/HAE via TSIP packet 2AH (see Appendix A).

3D Manual

In manual 3D mode, the Lassen iQ GPS receiver will only generate 3-dimensional (3D) position solutions (latitude, longitude, and altitude). A 3D solution requires at least four visible satellites which pass the mask criteria. If less than four conforming satellites are visible, the Lassen iQ GPS receiver will suspend position data outputs.

2D/3D Automatic

The default operating mode for the Lassen iQ GPS receiver is 2D/3D Automatic. In this mode, the Lassen iQ GPS receiver attempts to generate a 3-dimensional (3D) position solution, if four or more satellites meeting the mask criteria are visible. If only three satellites are visible which meet the mask criteria, the Lassen iQ GPS receiver will automatically switch to 2-dimensional (2D) mode and will use the last calculated altitude, if available, or the default altitude in the position solution. In 2D/3D Automatic mode, the PDOP switch is active.

Differential GPS Operating Modes

The default mode for the Lassen iQ GPS receiver is DGPS Automatic. The receiver supports three DGPS Modes: On, Off, and Automatic. The mode may be changed by issuing the appropriate TSIP command (see Appendix A for details).

DGPS On

When DGPS On is selected, the Lassen iQ GPS receiver will only provide differential GPS solutions. If the source of the correction data is interrupted or becomes invalid, the receiver will suspend output of all position, course and speed data. When a valid source of correction data is restored, the receiver will resume outputting data.

DGPS Off

When DGPS Off is selected, the Lassen iQ GPS receiver will not provide differential GPS solutions even if a valid source of correction data is supplied. In this mode, the receiver will only supply standard GPS position data.

DGPS Automatic

DGPS Automatic is the default operating mode for the Lassen iQ GPS receiver. In this mode, the receiver will provide differential GPS suitability when valid correction data is available. If a set of differentially correctable satellites cannot be found which meet the satellite mask settings, the receiver will transition to output standard GPS solutions. The Lassen iQ GPS receiver automatically switches between DGPS and standard GPS based on the availability of valid correction data.

Differential GPS Operation

The Lassen iQ GPS receiver is capable of accepting and decoding RTCM-104 data, the industry standard protocol for differential correction data. The receiver is configured to accept RTCM SC-104 correction data over Port 2 (PIN 6). Alternatively, you can use TSIP packet 60 or the TAIP DC message to input differential corrections through the primary serial port (PIN 3).

Position Accuracy

GPS position accuracy is degraded by atmospheric distortion, satellite geometry, satellite clock errors, and receiver clock errors. Effective models for atmospheric distortion of satellite signals have been developed to minimize the impact of tropospheric and ionospheric effects. The impact of satellite clock errors is minimized by incorporating the clock corrections transmitted by each satellite used in the position solution.

Coordinate Systems

Once the Lassen iQ GPS receiver achieves its first fix, it is ready to commence output of position, velocity, and time information. This information is output over serial communication channel in either the TSIP or NMEA protocol, as determined by the settings of the receiver. These protocols are defined in the Appendices. To change from one protocol to another, see Appendix A.

TSIP Coordinate Systems

TSIP has the widest choice of coordinate systems. The output format is chosen by TSIP command 0x35. The output formats include the following:

- LLA position — Latitude, longitude, altitude (LLA) according to the WGS-84 ellipsoid. Altitude can be chosen to be height above ellipsoid (HAE) or height above mean sea level (MSL).
- ENU velocity — ENU velocity is the velocity in East, North, and Up coordinates. These coordinates are easily converted to speed and heading.
- ECEF position and velocity — ECEF position and velocity is Earth-Centered, Earth-Fixed frame is a Cartesian coordinate frame with its center at the earth's center, the z-axis through the North Pole, and the x-axis through longitude 0 degrees, latitude 0 degrees. Velocity is reported relative to the same axes.

There are also two time coordinate systems:

- GPS time — GPS time is determined by an ensemble of atomic clocks operated by the Department of Defense (DOD).
- UTC time — UTC time is the world standard maintained by an ensemble of atomic clocks operated by government organizations around the world. UTC time replaced GMT (Greenwich Mean Time) as the world standard, in 1986.

GPS time is steered relative to Universal Coordinated Time (UTC). GPS does not recognize leap seconds resulting in a situation where GPS time is currently 13 seconds ahead of UTC time. Time tags for most output messages can be in either UTC time or GPS time, as chosen by TSIP command 0x35.

NMEA 0183

The NMEA 0183 protocol only supports LLA format and UTC time. Velocity is always described as horizontal speed and heading; vertical speed is not output.

Performance Characteristics

Update Rate

The Lassen iQ GPS receiver computes and outputs position solutions once per second, on the second. NMEA outputs can be scheduled at a slower rate using TSIP command 0x7A (see Appendix A). TAIP outputs may be controlled with TSIP packet 0x7E.

Dynamic Limits

The dynamic operating limits for the Lassen iQ GPS receiver are listed below. These operating limits assume that the GPS module is correctly embedded and that the overall system is designed to operate under the same dynamic conditions.

Table 4.2 Lassen iQ GPS Receiver Operating Limits

Operation	Limit
Acceleration	4 g (39.2 m/s ²)
Jerk	20 m/s ³
Speed	500 m/s
Altitude	18,000 m

Note – The Lassen iQ GPS Receiver firmware contains an algorithm that allows either the speed limit or altitude limit to be exceeded, but not both. This allows the receiver to be used in high altitude (research balloon) applications without a special factory configuration.

Re-Acquisition

Re-acquisition time for a momentary signal blockages is typically under 2 seconds.

When a satellite signal is momentarily interrupted during normal operation, the receiver continues to search for the lost signal at the satellite's last known Doppler frequency. If the signal is available again within 15 seconds, the receiver will normally re-establish track within two seconds. If the lost signal is not re-acquired within 15 seconds, the receiver initiates a broader frequency search. The receiver will continue to search for the satellite until it falls below the elevation mask.

Lassen iQ GPS Receiver Sensitivity Modes

The Lassen iQ GPS receiver features two sensitivity modes: Standard Sensitivity (default) and Enhanced Sensitivity.

Standard Sensitivity Mode

In the Standard Sensitivity mode, the receiver acquires GPS satellite signals in Cold Start, Warm Start, and Hot Start TTFF using 1 ms PDI (Pre-Detection Integration) setting to search the frequency range. Considering the fact that the minimum integration time of the GPS signal (1 ms PDI) has been applied, the receiver is optimized for faster acquisition times.

In the standard mode, the default setting for the AMU mask (Amplitude Measurement Unit) is 2. AMU mask establishes the minimum signal strength that the receiver will use for GPS (position, velocity and time) calculations.

The standard mode settings are AMU Mask = 2 and PDI = 1 ms. These standard mode settings are the factory recommendations for fastest acquisition and best performance under normal signal conditions.

Enhanced Sensitivity Mode

Enhanced Sensitivity mode enables the receiver to acquire lower strength GPS satellite signals and generate position fixes under poor signal conditions. When the Enhanced Mode is enabled, the receiver will begin its search for GPS satellite signals using a 1ms PDI acquisition. If no valid GPS satellite signals are detected after one complete frequency search, the receiver will switch to the extended PDI acquisition of 5 ms. Using a longer PDI allows the unit to detect lower level signals but does require longer to complete the frequency search.

In addition to the automatic switch to an extended PDI if needed, the Enhanced Sensitivity mode also uses a lower AMU mask. When Enhanced Sensitivity mode is enabled, the AMU mask is immediately set to the lower value of 1.2. This lower setting allows weaker signals to pass the filters of the GPS system and be used for calculating the position.

The default AMU mask for the Enhanced Sensitivity is 1.2. The user can change the AMU mask to a different value. When this is done, the receiver will overwrite the default setting of 1.2 and use the selected AMU.

The enhanced mode settings for the first frequency sweep are AMU Mask= 1.2 and PDI = 1 ms. If the receiver can not acquire after the first frequency sweep, the enhanced mode settings are AMU Mask= 1.2 and PDI = 5 ms. The user will also experience extended startup times.

Extended Startup Times

Due to the extended PDI acquisition in the Enhanced Sensitivity Mode, longer TTFF times (Time to First Fix) is normal. In the Enhanced Sensitivity Mode, the receiver is optimized for increased sensitivity, 6 dB more sensitive than the standard setting, at the cost of the longer startup times. This means that operating in the higher sensitivity mode is a trade-off between the faster start up times of the standard mode versus the higher sensitivity of the Enhanced Sensitivity mode. Therefore, the user must determine for each particular application which sensitivity mode will provide the best performance.

The following tables illustrate the comparison between the TTFF times in Standard and Enhanced Sensitivity modes. Note that the Enhanced Mode is not applicable for Cold Starts.

Table 4.3 Standard Sensitivity Mode TTFF Times

Standard Sensitivity Mode	50% (sec)	90% (sec)
Hot Start	10	13
Warm Start	38	42

Table 4.4 Enhanced Sensitivity Mode TTFF Times

Standard Sensitivity Mode	50% (sec)	90% (sec)
Hot Start	TBD	TBD
Warm Start	TBD	TBD

Enabling the Enhanced Sensitivity Mode

New TSIP Command

The Lassen iQ GPS receiver is configured from the factory with the Enhanced Sensitivity feature turned off. A new TSIP (Trimble Standard Interface Protocol) command and a new set of APIs have been generated for switching between the Standard and the Enhanced Sensitivity Modes. You can turn the Enhanced Sensitivity feature on, using one of three tools:

- The iQ_CHAT program found in the iQ Starter Kit or
- The iQ_Monitor program found in the iQ Starter Kit or
- The new TSIP Command Packet 0x69. The Lassen iQ GPS receiver will respond with the new TSIP response packet 0x89. A soft reset is required to make the switch effective. Following are the details of the command packet 0x69 and report packet 0x89.

Table 4.5 Command Packet 0x69 Set/Request Enhanced Sensitivity Mode

Byte	Item	Type	Value	Definition
0	Enhanced Sensitivity Mode	Byte	0	Off (standard)
			1	On (enhanced)
1	Reserved			

Table 4.6 Report Packet 0x89 Report Enhanced Sensitivity Mode

Byte	Item	Type	Value	Definition
0	Current Enhanced Sensitivity Mode	Byte	0	Off (standard)
			1	On (enhanced)
1	Enhanced Sensitivity Mode After Reset	Byte	0	Off (standard)
			1	On (enhanced)

In order to change the receiver to the Enhanced Sensitivity Mode completely and take effect, a soft reset is required. To permanently set the Lassen iQ GPS receiver to the Enhanced Sensitivity mode, the settings can be saved to flash memory using the TSIP 8Ex26 Command.

Setting the Enhanced Sensitivity Mode

Following is a 'typical' scenario using the TSIP packets 0x69 and 0x89.

1. Request the current sensitivity status from a factory configured Lassen iQ GPS receiver.

Send Packet 0x69 with no data. The Lassen iQ GPS receiver will respond with Packet 0x89; byte 0 = 0; byte 1 = 0.

2. Turn on the Enhanced Sensitivity feature.

Send Packet 0x69 with byte 0 = 1. The Lassen iQ GPS receiver will respond with Packet 0x89; byte 0 = 0; byte 1 = 1.

Send Packet 0x25 (soft reset). The Lassen iQ GPS receiver will respond with Packet 0x45 (Software Version Information)

Send Packet 0x69 with no data. The Lassen iQ GPS receiver will respond with Packet 0x89; byte 0 = 1; byte 1 = 1.

3. The Lassen iQ GPS receiver is now in Enhanced Sensitivity mode until a cold start command is executed or a power cycle is initiated.

To Permanently set The Enhanced Sensitivity Mode

1. Execute the 8Ex26 command before the cold start or power cycle is executed.
2. The 8Ex26 command sets the enhanced sensitivity configuration into flash memory.

Lassen iQ GPS Receiver Aided GPS Feature

This feature allows the Lassen iQ GPS receiver to take advantage of the fast startup times of hot start. The fast hot startup times can be achieved by uploading almanac, ephemeris, time, and position to the receiver using TSIP packets. There are two methodologies to provide this information. One is to use the iQ_Monitor program by downloading and uploading the information through the Starter kit. The second methodology is for the user to write an application using TSIP commands to download and upload the appropriate information in his own application.

Warning – To ensure proper format of the ephemeris file and almanac file, a Trimble receiver must be used to gather this data. Using almanac files from non-Trimble receivers may not be in proper format and thus may not work, i.e. almanac files downloaded from the Internet.

iQ_Monitor Method

1. Attach the Lassen iQ GPS receiver starter box to your PC.
2. Place the GPS antenna, where there is a clear view of sky.
3. Allow the starter kit box to run and to calculate fixes.
4. On the main screen, wait for the almanac indicator to turn green indicating that the receiver has collected almanac.

Note – It takes 12,5 minutes of uninterrupted iQ operation to collect almanac from the satellites.

5. Click on the initialized pulldown menu and use the download features on the bottom of the pulldown to download the almanac, position, time and ephemeris to files on your PC.
6. Now that you have collected these files, you can upload them using the upload features on the initialize pulldown window in iQ_Monitor.

Note – The collected ephemeris will be only good for approximately 2 hours.

The TSIP Commands Method

1. Allow the receiver to run long enough to collect almanac.

Note – It takes 12,5 minutes of uninterrupted iQ operation to collect almanac from the satellites.

2. Use packet 0x26 to request the health of the receiver. The response packets 0x46 and 0x4B indicate when the almanac is complete and current.
3. Use packet 0x38 to request the almanac and the ephemeris. The receiver responds with packet 0x58.
4. Use packet 0x21 to request time from the receiver. The receiver responds with packet 0x41 and this can be used to set your own off-board clock.
5. You also need to request position from the receiver. This can be done by using packets 0x42, 0x4A, 0x83 Or 0x84.

To upload this information back to the receiver, the following order of the upload commands shall be followed:

1. Upload the time using packet 0x2E. Wait for upload confirmation report packet 0x41.
2. Upload position using packet 0x31 or 0x32. No confirmation report packet available.
3. Upload the ephemeris, using packet 0x38. Wait for upload confirmation report packet 0x58.
4. Upload almanac using packet 0x38. Wait for upload confirmation report packet 0x58.

Note – For details regarding all the mentioned TSIP packets, see Appendix A.

Warning – To operate the Lassen iQ GPS receiver under Hot Start conditions, the following conditions are required. 1) The almanac must be valid. Almanac data is generally valid for 4-6 months. The Lassen iQ GPS receiver automatically flushes almanac every 8 weeks. 2) The ephemeris must be less than 2 hours old. 3) The position must be within 100 Km of the current iQ position. 4) Time must be within 5 minutes of UTC.

GPS Timing

In many timing applications, such as time/frequency standards, site synchronization systems and event measurement systems, GPS receivers are used to discipline local oscillators.

The GPS constellation consists of 24 orbiting satellites. Each GPS satellite contains a highly-stable atomic (Cesium) clock, which is continuously monitored and corrected by the GPS control segment. Consequently, the GPS constellation can be considered a set of 24 orbiting clocks with worldwide 24-hour coverage.

GPS receivers use the signals from these GPS “clocks” to correct its internal clock, which is not as stable or accurate as the GPS atomic clocks. GPS receivers like the Lassen iQ GPS receiver output a highly accurate timing pulse (PPS) generated by its internal clock, which is constantly corrected using the GPS clocks. This timing pulse is synchronized to UTC within ± 50 ns.

In addition to serving as a highly accurate stand-alone time source, GPS receivers are used to synchronize distant clocks in communication or data networks. This synchronization is possible since all GPS satellite clocks are corrected to a common master clock. Therefore, the relative clock error is the same, regardless of which satellite or satellites are used. For timing applications requiring a “common clock”, GPS is the ideal solution.

The position and time errors are related by the speed of light. Therefore, a position error of 100 meters corresponds to a time error of approximately 333 ns. The hardware and software implementation affects the GPS receiver's PPS accuracy level. The receiver's clocking rate determines the PPS steering resolution.

The Lassen iQ GPS receiver clocking rate is 12.504 MHz. This rate corresponds to a steering resolution of ± 40 ns.

Serial Time Output

The TSIP, TAIP, and NMEA protocols include time messages. See report packets 41 and 8F-20 in Appendix A for a description of the time reports for the TSIP protocol. See the TAIP Appendix for a description of the TM message. See the NMEA Appendix for a description of the ZDA message.

Note – GPS time differs from UTC (Universal Coordinated Time) by a variable, integer number of seconds $UTC=(GPS\ time)-(GPS\ UTC\ offset)$.

As of January 2005, the GPS UTC offset was 13 seconds. The offset has historically increased by 1 second about every 18 months. The GPS Control Organization has not added leap seconds on its usual 18 month schedule. As a result, the offset remains at 13 seconds. System designers should plan to read the offset value as a part of the timing interface to obtain UTC. The GPS week number is in reference to a base week (Week #0), starting January 6, 1980.

Pulse-Per-Second (PPS)

The Lassen iQ GPS receiver provides a four microsecond wide, CMOS compatible TTL level Pulse-Per-Second (PPS). The PPS is a positive pulse available on pin 4 of the Lassen iQ GPS receiver power and I/O connector. The rising edge of the PPS pulse is synchronized with respect to UTC. The timing accuracy is ± 50 nanoseconds when valid position fixes are being reported.

The rising edge of the pulse is typically less than 20 nanoseconds. The distributed impedance of the attached signal line and input circuit can affect the pulse shape and rise time. The PPS can drive a load up to 5mA without damaging the module. The falling edge of the pulse should not be used. The PPS is always on (early PPS) and is driven by the Real Time Clock (RTC) until the receiver acquires GPS time from the satellite and is obtaining fixes. The PPS is output immediately after main power is applied, and continues even if the receiver loses GPS lock. The drift of the PPS, when the Lassen iQ GPS receiver is not tracking satellites, is unspecified and should not be used for synchronization.

PPS Output Mode

PPS output mode can be controlled by TSIP command packet 0 x 35. Once a specific mode is selected, it can be stored in non-volatile memory (flash) using TSIP command 0x8E-26. The following PPS modes are supported.

Always Off

When the *Always Off* mode is selected, the PPS output remains low at all times. Disabling the PPS output has no affect on normal receiver operations, and position fixes are calculated as usual. This mode can be selected at any time during receiver operation. The PPS output is immediately switched off (disabled) when the TSIP command for this mode is received.

Always On (default)

When the PPS output is configured for *Always On* (early PPS), it is driven by the Real Time Clock (RTC) until the receiver acquires GPS time is generating position fixes. In this mode, the PPS output continues even if the receiver loses GPS tracking. The maximum drift of the PPS pulse when not tracking satellites could be quite large, therefore the PPS output should not be used for precise synchronization when no position fix occurs. The PPS can be switched to *Always On* mode any time during normal operation. This mode is the factory default setting.

Fix Based

In this mode, the PPS output is turned on only while fixes are taking place. If the receiver is not tracking satellites, the PPS output is turned off until the signals are required and position fixes are valid again. If the receiver is switched from *Always On* to *Fix Mode*, and the receiver has not yet started generating position fixes, the PPS output will turn off until a new fix is obtained.

Programmable Characteristics - Signal Offset (Cable Delay Compensation)

The receiver firmware also enables the user to offset the delay of the PPS pulse with reference to the actual UTC second tick. This delay is the result of antenna cable length and propagation delay of the PPS output signal. The delay compensation parameter can be set (in nano seconds) using TSIP super packet 0x8E-4A. Note that the current firmware version only allows the update of the PPS offset parameter of the PPS definition packet (0x8E-4A). Other parameters are read only. The PPS offset selection can be stored in non-volatile memory by sending command packet 0x8E-26 to the receiver.

Note – Trimble Navigation has measured better than 50 nanoseconds accuracy of the Lassen iQ GPS receiver PPS signal in static mode. For more information on timing applications, contact your Trimble sales representative.

System Architecture

The Lassen iQ GPS receiver (see Figure 4.7) uses twelve processing channels operating on the L1 frequency of 1575.42 MHz and using the coarse acquisition (C/A) code. The module uses custom integrated circuitry designed by Trimble to track the GPS satellite signals. These ICs also contain support circuitry to the navigation processor. An integrated 32-bit microprocessor is used for tracking, computing a position, and performing the I/O operations.

The Lassen iQ GPS receiver receives the amplified GPS satellite signals through the antenna feed line connector and passes them to the RF down converter. A highly stable crystal reference oscillator operating at 12.504 MHz is used by the down converter to produce the signals used by the 12-channel signal processor. The 12-channel signal processor tracks the GPS satellite signals and extracts the carrier code information as well as the navigation data at 50 bits per second.

Operation of the tracking channels is controlled by the navigation processor. The tracking channels are used to track the highest twelve satellites above the horizon. The navigation processor will then use the optimum satellite combination to compute a position. The navigation processor also manages the ephemeris and almanac data for all of the satellites, and performs the data I/O.

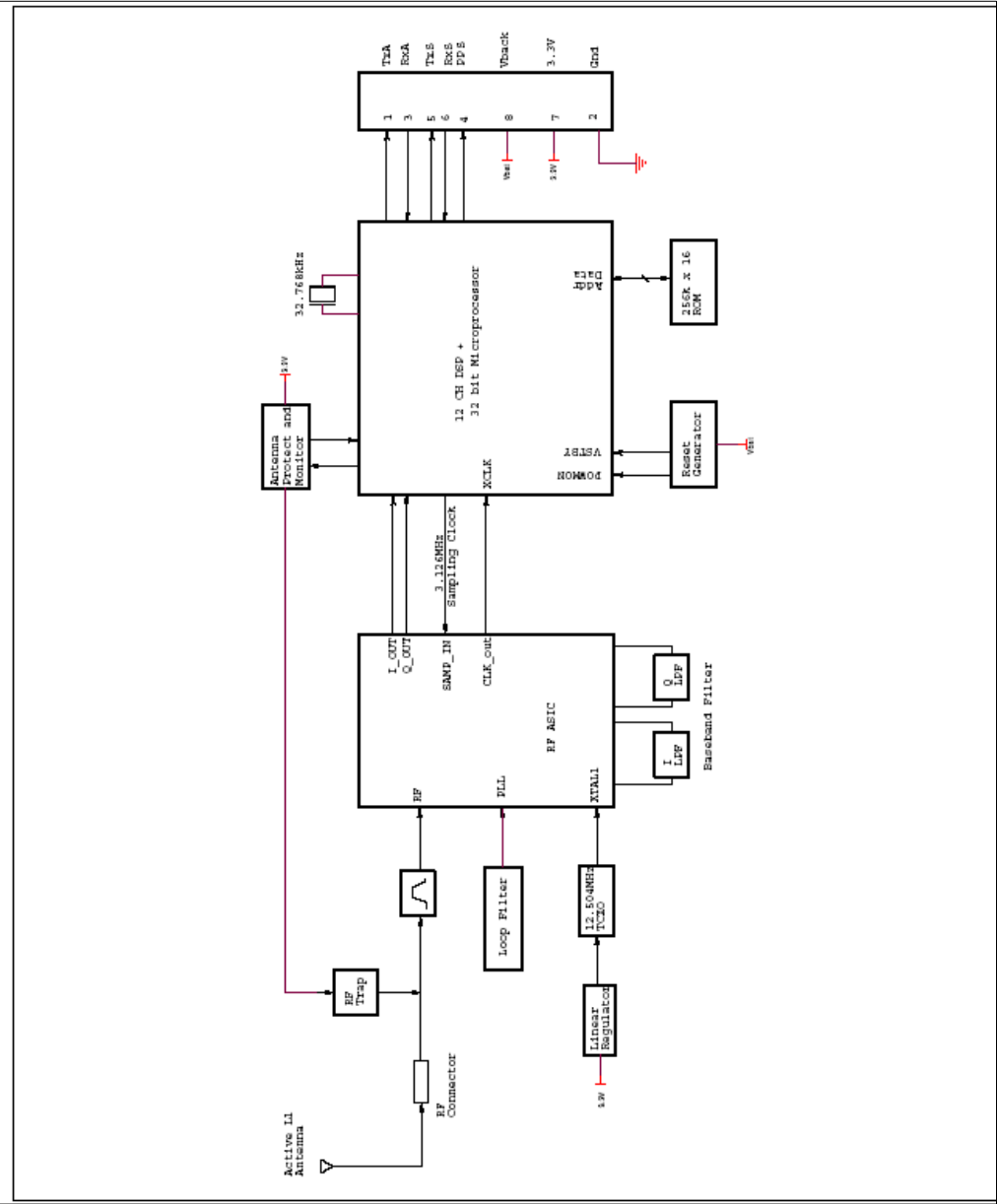

Figure 4.7 Lassen iQ GPS receiver Block Diagram



Trimble Standard Interface Protocol (TSIP)

The Trimble Standard Interface Protocol (TSIP) provides the system designer with over 20 commands that may be used to configure a GPS receiver for optimum performance in a variety of applications. TSIP enables the system designer to customize the configuration of a GPS module to meet the requirements of a specific application.

This appendix provides the information needed to make judicious use of the powerful features TSIP has to offer, to greatly enhance overall system performance, and to reduce the total development time. The provided reference tables will help you determine which packets apply to your application. For those applications requiring customization see Customizing Receiver Operations, page 89 for a detailed description of the key setup parameters. Application guidelines are provided for each TSIP Command Packet, beginning on page 102.

Interface Scope

The Trimble Standard Interface Protocol is used extensively in Trimble receiver designs. The protocol was originally created for the Trimble Advanced Navigation Sensor (TANS) and is colloquially known as the TANS protocol even though the protocol applies to many other devices.

The Lassen iQ GPS receiver has two serial I/O communications ports. These are bi-directional control and data ports. The data I/O port characteristics, protocol definitions, and other options are user programmable and can be stored in non-volatile FLASH memory.

The TSIP protocol is based on the transmission of packets of information between the user equipment and the unit. Each packet includes an identification code (1 byte, representing 2 hexadecimal digits) that identifies the meaning and format of the data that follows. Each packet begins and ends with control characters.

This document describes in detail the format of the transmitted data, the packet identification codes, and all available information over the output channel to allow the user to choose the data required for his particular application. As will be discussed, the receiver transmits some of the information (position and velocity solutions, etc.) automatically when it is available, while other information is transmitted only on request. Additional packets may be defined for particular products and these will be covered in the specifications for those products as necessary.

The iQ_CHAT utility, part of the GPS Tool Kit, is designed to exercise many of the TSIP packets.

Packet Structure

TSIP packet structure is the same for both commands and reports. The packet format is:

```
<DLE> <id> <data string bytes> <DLE> <ETX>
```

Where:

- <DLE> is the byte 0x10
- <ETX> is the byte 0x03
- <id> is a packet identifier byte, which can have any value excepting <ETX> and <DLE>.

The bytes in the data string can have any value. To prevent confusion with the frame sequences <DLE> <ID> and <DLE> <ETX>, every <DLE> byte in the data string is preceded by an extra <DLE> byte ('stuffing'). These extra <DLE> bytes must be added ('stuffed') before sending a packet and removed after receiving the packet. Notice that a simple <DLE> <ETX> sequence does not necessarily signify the end of the packet, as these can be bytes in the middle of a data string. The end of a packet is <ETX> preceded by an odd number of <DLE> bytes.

Multiple-byte numbers (integer, float, and double) follow the ANSI/IEEE Std. 754 IEEE Standard for binary Floating-Point Arithmetic. They are sent most-significant byte first. This may involve switching the order of the bytes as they are normally stored in Intel based machines. Specifically:

- UINT8 = Byte: An 8 bit unsigned integer.
- UINT16 = Word: A 16 bit unsigned integer.
- INT16 = Integer: A 16 bit integer.
- INT32 = Long: A 32 bit integer.
- UINT32 = ULong: A 32 bit unsigned integer.
- Single — Float, or 4 byte REAL has a precision of 24 significant bits, roughly 6.5 digits.
- Double — 8 byte REAL has a precision of 52 significant bits. It is a little better than 15 digits.

Automatic Output Packets

The Lassen iQ GPS receiver receiver is configured to automatically output the following packets. For minimal system implementations, these output packets provide all of the information required for operation including time, position, velocity, and receiver and satellite status and health. Position and velocity are reported using one or more of the packets listed below, depending on the selected I/O options. While there are other packets automatically output, the following packets provide the information most commonly used. No input packets are required.

Table A.1 Automatic Output Packets

Output Packet ID	Description	Reporting Interval
0x41	GPS time	5 seconds
0x42, 0x83, 0x4A, 0x84, 0x8F-20	position (choose packet with I/O options)	1 second
0x43, 0x56, 0x8F-20	velocity (choose packet with I/O options)	1 second
0x46	health of receiver	5 seconds
0x4B	machinecode/status (includes antenna fault detect)	5 seconds
0x6D	all-in-view satellite selection, DOPs, Fix Mode	1 second
0x82	DGPS position fix mode (only in DGPS mode)	1 second

Customizing Receiver Operations

For information on customizing receiver operations, see the following tables on selecting report data.

Automatic Position and Velocity Reports

The receiver automatically outputs position and velocity reports at set intervals. Automatic report packets are controlled by Packet 35. Setting the control bits as indicated in the table below allows you to control which position and velocity packets are output.

Table A.2 Packet 35: Automatic Position and Velocity Reports Control Setting Bits

Report Packet ID	Requested Setting	Packet 0x35, Byte 0				Packet 0x35, Byte 1	
		Bit 0	Bit 1	Bit 4	Bit 5	Bit 0	Bit 1
0x42	single precision XYZ position	1		0			
0x83	double-precision XYZ position	1		1			
0x4A	single-precision LLA position		1 (default)	0			
0x84	double-precision LLA position		1	1			
0x43	velocity fix (XYZ, ECEF)					1	
0x56	velocity fix (ENU)						1(default)
0x8F-20	LLA and ENU				1		

Initialization Packets to Speed Start-up

If you are not supplying the receiver with battery power when main power is off, you can still “warm-start” the receiver by sending the following commands after the receiver has completed its internal initialization and has sent Packet 82.

Table A.3

Input Byte	Description
0x2B	initial position
0x2E	initial time
0x38	almanac (for each SV)
0x38	almanac health
0x38	ionosphere page
0x38	UTC correction

Packets Output at Power-Up

The following table lists the messages output by the receiver at power-up. After completing its self-diagnostics, the receiver automatically outputs a series of packets which indicate the initial operating condition of the receiver. Messages are output as listed in the table below. After Packet 82 is output, the sequence is complete and the receiver is ready to accept commands.

Table A.4 Packet Power-up Output Messages

Output ID	Description	Notes
0x45	software version	--
0x46	receiver health	--
0x4B	machine code/status	--
As chosen, see Table A.3 default: 0 x 4A, 0 x 56	position/Velocity output	As chosen, see Table A.3.
0x41	GPS time	
82	DGPS position fix mode	--

Timing Packets

If you are using the Lassen iQ GPS receiver as a timing system, you may need to implement the following TSIP control commands.

Table A.5 Timing Packet TSIP Control Commands

Input ID	Description	Output ID
0x21	get the current GPS time	0x41
0x38-05	request UTC parameters	0x58-05

Satellite Data Packets

The following packets contain a variety of GPS satellite data.

Table A.6 Satellite Data Packet Data I/O Descriptions

Input ID	Description	Output ID
0x27	request signal levels	0x47
0x38	request/load satellite system data	0x58
0x3C	request tracking status	0x5C

Backwards Compatibility

TSIP packets implemented in the Lassen iQ GPS receiver are backward compatible with those used in Lassen SK II GPS receiver. For information regarding compatibility with other Trimble receivers, contact the Trimble Technical Assistance Center.

Recommended TSIP Packets

Table A.7 Recommended TSIP Packet Data

Function	Description	Input	Output
Protocol and port setup	set/query port configuration	0xBC	0xBC
	set/query NMEA configuration	0x7A	0x7B
	set/query I/O options (autoreport and format options)	0x35	0x55
Navigation	GPS time	0x21	0x41
	position & velocity (superpacket)	0x8E-20 or 0x37 or auto	0x8F-20
	double-precision LLA	0x37/auto	0x84
	double-precision XYZ	0x37/auto	0x83
	ENU velocity	0x37/auto	0x56
	XYZ velocity	0x37/auto	0x43
Satellite and tracking information	query receiver state (health)	0x26	0x46, 0x4B
	query current satellite selection	0x24	0x6D
	query signal levels	0x27	0x47
	query satellite information (azimuth, elevation, etc.)	0x3C	0x5C
Receiver settings	query software version	0x1F	0x45
	query receiver ID & error status	0x26	0x4B, 0x46
	set/query receiver configuration	0xBB	0xBB
	set altitude for 2D mode	0x2A	0x4A
	disable PV/altitude filters	0x70	0x70
	set/query positioning mode (2D v. 3D)	0xBB	0xBB
GPS System	query/load GPS system data	0x38	0x58

Table A.7 (Continued) Recommended TSIP Packet Data

Function	Description	Input	Output
Initialization	full reset (clear battery backup and/or non-volatile settings)	0x1E	
	soft reset	0x25	
	set GPS time	0x2E	0x4E
	set exact LLA	0x32	
	set approx. XYZ	0x23	
	set approx. LLA	0x2B	
	set exact XYZ	0x31	

Command Packets Sent to the Receiver

The table below summarizes the command packets sent to the receiver. The table includes the input Packet ID, a short description of each packet, and the associated response packet. In some cases, the response packets depend on user-selected options. These selections are covered in the packet descriptions beginning on page 102.

Table A.8 User-Selected Command Packet Options

Input ID	Packet Description	Output ID
0x1E	clear battery back-up/reset	See Note 1
0x1F	software version	0x45
0x21	current time	0x41
0x23	initial position (XYZ ECEF)	--
0x24	request receiver position fix mode	0x6D
0x25	soft reset & self-test	See Note 1
0x26	receiver health	0x46, 0x4B
0x27	signal levels	0x47
0x2A	altitude for 2-D mode	0x4A

Table A.8 User-Selected Command Packet Options (Continued)

Input ID	Packet Description	Output ID
0x2B	initial position (Lat, Lon, Alt)	--
0x2D	oscillator offset	0x4D
0x2E	set GPS time	0x4E
0x31	accurate initial position (XYZ Cartesian ECEF)	--
0x32	accurate initial position	--
0x35	I/O options	0x55
0x37	status and values of last position and velocity	0x57
0x38	load or request satellite system data	0x58
0x3C	tracking status	0x5C, see Note 2
0x69	enhanced sensitivity	0x89
0x70	filter configuration	0x70
0x7A	set/request NMEA output configuration	0x7B
0xBB	set receiver configuration	0xBB
0xBC	set port configuration	0xBC
0x8E-20	last fix with extra information (fixed point)	0x8F-20
0x8E-26	Store settings in Flash memory.	0x8F-26

Note 1 – Output is determined by packet 0 x 35. See Table A.4 to determine which messages are output at power-up.

Note 2 – No response sent if data is not available.

Report Packets Sent by the Receiver to the User

The table below summarizes the packets output by the receiver. The response packets may depend on user-selected options (see page 82).

Table A.9 User-Selected Report Packet Options

Output ID	Packet Description	Input ID
0x41	GPS time	0x21, auto
0x42	single-precision XYZ position	0x37, auto
0x43	velocity fix (XYZ ECEF)	0x37, auto
0x45	software version information	0x1F, power-up
0x46	health of Receiver	0x26, auto, power-up
0x47	signal level for all satellites	0x27
0x4A	single-precision LLA position	0x37, auto
0x4B	machine code/status	0x26, auto, power-up
0x4D	oscillator offset	0x2D
0x4E	response to set GPS time	0x2E
0x55	I/O options	0x35
0x56	velocity fix (ENU)	0x37, auto
0x57	information about last computed fix	0x37
0x58	GPS system data/acknowledge	0x38
0x5C	satellite tracking status	0x3C
0x6D	all-in-view satellite selection	0x24, auto
0x82	differential position fix mode	0x62, auto
0x83	double-precision XYZ	auto, 0x37
0x84	double-precision LLA	auto, 0x37
0x89	enhanced sensitivity	0x69
0x8F-20	last fix with extra information (fixed point)	auto, 0x37, 0x8E-20
0xBB	GPS navigation configuration	0xBB
0xBC	Receiver port configuration	0xBC

Key Setup Parameters or Packet BB

Selecting the correct operating parameters has significant impact on receiver performance. Packet 0xBB (set receiver configuration) controls the key setup parameters.

The default operating parameters allow the receiver to perform well in almost any environment. The user can optimize the receiver to a particular application if the vehicle dynamics and expected level of obscuration are understood. If the receiver is then taken out of this environment, the specifically tuned receiver may not operate as well as a receiver with the default options.

The table below lists suggested parameter selections as a function of obscuration and whether accuracy or fix density is important. In this table, NA indicates that the operating parameter is not applicable, DC (don't care) indicates that the user may choose the operating parameter.

Table A.10 Setup Parameters in Packet 0xBB

Parameter	Accuracy	Fixes	Factory Default
Fix mode	Man 3D	AUTO	AUTO
Dynamics code	Land	Land	Land
Elevation mask	10°	5°	5°
Signal mask	6.0	4.0	2.0
DOP mask	6.0	12.0	12.0
DOP switch	NA	8.0	6.0
DGPS correction age	10 Seconds	N/A	30 Seconds

The default values in Table A.10 allow the receiver to operate well under the most varied and demanding conditions. A user may choose to change the default parameters if the receiver is only required to perform in a specific or limited environment. The user should be warned that when the receiver is exposed to operating conditions which are different from the conditions described by the user setup, then the performance may be degraded.

Initially, the user must consider the environment in which the receiver is expected to operate. There is a trade-off between how frequently a position fix is output versus the absolute accuracy of the fix. The user must decide which takes priority and then make the appropriate selections. This becomes increasingly important when frequent satellite blockages are expected, as in downtown “urban canyon” environments and heavily foliated areas.

Following is a description of the key fields in Packet 0xBB.

Set Fix Mode

Packet 0xBB is used to choose the appropriate position fix mode for your application: 2-D, 3-D or AUTO. The default mode is AUTO 2-D/3-D, where the receiver first attempts to obtain a 3-D solution with a PDOP below the DOP switch. If this is not possible, then the receiver attempts to obtain a 2-D solution with a DOP less than the DOP mask. This mode supplies fairly continuous position fixes even when there is frequent obscuration. This mode is preferable for most land or air applications, where altitude changes are occurring and there is occasional obscuration.

The highest accuracy fix mode is 3-D manual, where altitude is always calculated along with the latitude, longitude, and time. However, this requires four satellites with a PDOP below the DOP mask set in Packet BB in order to obtain a position. Normally, this will provide the most accurate solution. Thus, if only 3-D solutions are desired, then the user should request 3-D manual mode. Depending on how the PDOP mask is set, this may be restrictive when the receiver is subjected to frequent obscuration, or when the geometry is poor due to an incomplete constellation.

Alternatively, if the user only wants a 2-D solution, then 2-D manual should be requested. In this case, the receiver uses either the last altitude obtained in a 3-D fix, or the altitude supplied by the user. However, any error in the assumed altitude will affect the accuracy of the latitude and longitude solution.

When using the 2-D mode, expect fixes with accuracies which are at best as accurate as the supplied altitude. If a marine user enters sea-level as the altitude, then small errors in the horizontal solution will occur when the sea state is rough or there are high tidal variations. However, these errors may be smaller than the altitude errors induced by SA, so 2-D may be preferable for a marine user who does not want to observe “unusual” altitudes.

Dynamics Code

The feature default is LAND mode, where the receiver assumes a moderate dynamic environment. In this case, the satellite search and re-acquisition routines are optimized for vehicle type environments. In SEA mode, the search and re-acquisition routines assume a low acceleration environment and reverts to user entered altitude in 2-D auto. In AIR mode, the search and re-acquisition routines are optimized for high acceleration conditions.

Elevation Mask

This is the minimum elevation angle for satellites to be used in a solution output by the receiver. Satellites which are near the horizon are typically more difficult to track due to signal attenuation, and are also generally less accurate due to higher variability in the ionospheric and tropospheric corruption of the signal. When there are no obstructions, the receiver can generally track a satellite down to near the horizon. However, when this mask is set too low, the receiver may experience frequent constellation switching due to low elevation satellites being obscured.

Frequent constellation switching is undesirable because position jumps may be experienced when SA is present and DGPS is not available to remove these effects. The benefit of a low elevation mask is that more satellites are available for use in a solution and a better PDOP may be yielded. The current mask is set to five degrees and provides a reasonable trade-off of the benefits and drawbacks. High accuracy users may prefer a mask angle around ten degrees, where the ionosphere and troposphere begin to be more predictable

Signal Level Mask

This mask defines the minimum signal strength for a satellite used in a solution. There is some internal hysteresis on this threshold which allows brief excursions below the threshold if lock is maintained and the signal was previously above the mask. The factory default mask has been set to 2 (AMU). High accuracy users may use a slightly higher mask of 6.0-8.0, since weaker measurements may be slightly noisier and are often caused by reflected signals which provide erroneous ranges.

One should also resist the temptation to set the elevation and SNR masks too low. The satellite geometry is sometimes improved considerably by selecting low elevation satellites. They are, however, subject to significant signal degradation by the greater ionospheric and tropospheric attenuation that occurs. They are also subject to more obscuration by the passing scenery when the receiver is in a moving vehicle. The code phase data from those satellites is therefore more difficult to decode and therefore has more noise.

***Note** – A level of hysteresis in the signal level mask is allowed in the core operating software. The hysteresis allows the receiver to continue using satellite signals which fall slightly below the mask and prevents the receiver from incorporating a new signal until the signal level slightly exceeds the mask. This feature minimizes constellation changes caused by temporary fluctuations in signal levels.*

DOP Mask and Switch

The DOP mask is the maximum DOP limit for any 2-D or 3-D position solution will be made. The DOP switch is the level at which the receiver stops attempting a 3-D solution, and tries for a 2-D solution when in automatic 2-D, 3-D mode. The switch level has no effect in either manual mode. Raising the DOP mask will generally increase the fix density during obscuration, but the fixes with the higher DOP will be less accurate (especially with SA present). Lowering the mask will improve the average accuracy at the risk of lowering the fix density.

Packet Descriptions

Command Packet 0x1E - Clear Battery Backup, then Reset

This packet commands the GPS receiver to clear all battery back-up data and to perform a software reset. This packet contains one data byte.

Table A.11 Command Packet 0x1E Format

Byte	Item	Type	Value	Definition
0	Reset mode	UINT 8	0x4B 0x46	Cold start: Erase BBRAM and restart Factory reset: Erase BBRAM and Flash and restart

Warning – All almanac, ephemeris, current position, mode, and communication port setup information is lost when executing the “Factory Reset” command. In normal use this packet should not be sent.

Warning – It is very helpful to keep a fresh copy of the current almanac, which is stored in the file GPSALM.DAT collected by the iQ_CHAT command “!”. This allows near-instantaneous recuperation by the receiver in case of power loss or clearing of battery-backed memory by using the iQ_CHAT command “@” to load it back into the receiver memory.

Command Packet 0x1F - Request Software Versions

This packet requests information about the version of software running in the Navigation and Signal Processors. This packet contains no data. The GPS receiver returns Packet 0x45.

Command Packet 0x21 - Request Current Time

This packet requests current GPS time. This packet contains no data. The GPS receiver returns Packet 0x41.

Command Packet 0x23 - Initial Position (XYZ Cartesian ECEF)

This packet provides the GPS receiver with an approximate initial position in XYZ coordinates. This packet is useful if the user has moved more than about 1,000 miles since the previous fix. (Note that the GPS receiver can initialize itself without any data from the user; this packet merely reduces the time required for initialization.) **This packet is ignored if the receiver is already calculating positions.** The data format is shown below.

Note – To initialize using the Latitude-Longitude-Altitude representation, use Command Packet 0x2B.

Table A.12 Command Packet 0x23 Data Format

Byte	Item	Type	Units
0-3	X	Single	Meters
4-7	Y	Single	Meters
8-11	Z	Single	Meters

Command Packet 0x24 - Request GPS Receiver Position Fix Mode

This packet requests current position fix mode of the GPS receiver. This packet contains no data. The GPS receiver returns Packet 0x6D.

Command Packet 0x25 - Initiate Soft Reset & Self Test

This packet commands the GPS receiver to perform a software reset. This is equivalent to cycling the power. The GPS receiver performs a self-test as part of the reset operation. This packet contains no data. Following completion of the reset, the receiver will output the start-up messages (see Table A.4). The GPS receiver sends Packet 0x45 only on power-up and reset (or on request); thus if Packet 0x45 appears unrequested, then either the GPS receiver power was cycled or the GPS receiver was reset.

Command Packet 0x26 - Request Health

This packet requests health and status information from the GPS receiver. This packet contains no data. The GPS receiver returns Packet 0x46 and 0x4B.

Command Packet 0x27 - Request Signal Levels

This packet requests signal levels for all satellites currently being tracked. This packet contains no data. The GPS receiver returns Packet 0x47.

Command Packet 0x2A - Altitude for 2-D Mode

Reference Altitude is the altitude used for manual 2-D positions if the altitude flag is set. Altitude is in units of HAE WGS-84 or MSL depending on the selected I/O options for the position. The Altitude Flag determines whether or not the Reference Altitude will be used. If set, it will be used. If cleared, altitude hold (last 3-D altitude) is used.

Note – With no data byte, this packet requests the current values of these altitude parameters. In this case, the GPS receiver returns Packet 4A.

This packet sets or requests the altitude parameters used for the Manual 2-D mode: Reference Altitude and Altitude Flag. Packet 0x4A (9 byte format) is returned.

Table A.13 Packet 0x2A Set Reference Altitude Description

Byte	Item	Type	Definition
0-3	Altitude	Single	Reference altitude for 2-D

Table A.14 Packet 0x2A Clear Reference Altitude Description

Byte	Item	Type	Value	Definition
0	Altitude Flag	UINT8	0 x FF	Clear Altitude flag

Note – With no data bytes, this packet requests the current values of these altitude parameters. In this case, the GPS receiver returns Packet 4A (9 byte format).

Command Packet 0x2B - Initial Position (Latitude, Longitude, Altitude)

This packet provides the GPS receiver with an approximate initial position in latitude and longitude coordinates (WGS-84). This packet is useful if the user has moved more than about 1,000 miles since the previous fix. (Note that the GPS receiver can initialize itself without any data from the user; this packet merely reduces the time required for initialization.) **This packet is ignored if the receiver is already calculating positions.** The data format is shown in the table below.

Table A.15 Command Packet 0x2B Data Format

Byte	Item	Type	Units
0-3	Latitude	Single	Radians, north
4-7	Longitude	Single	Radians, east
8-11	Altitude	Single	Meters

Note – To initialize with ECEF position, use Command Packet 0x23.

Command Packet 0x2D - Request Oscillator Offset

This packet requests the calculated offset of the GPS receiver master oscillator. This packet contains no data. The GPS receiver returns Packet 0x4D. This packet is used mainly for service. The permissible oscillator offset varies with the particular GPS receiver unit.

Command Packet 0x2E - Set GPS Time

This packet provides the approximate GPS time of week and the week number to the GPS receiver. The GPS receiver returns Packet 0x4E. The data format is shown below. The GPS week number reference is Week # 0 starting January 6, 1980. The seconds count begins at the midnight which begins each Sunday morning. This packet is usually not required when the battery back-up voltage is applied as the internal clock keeps time to sufficient accuracy. **This packet is ignored if the receiver has already calculated the time from tracking a GPS satellite.**

Note – See report Packet 41 for information on the Extended GPS week number.

Table A.16 Command Packet 0x2E Data Formats

Byte	Item	Type	Units
0-3	GPS time of week	Single	Seconds
4-5	Extended GPS week number	INT16	Weeks

Command Packet 0x31 - Accurate Initial Position (XYZ Cartesian ECEF)

This packet is identical in content to Packet 0x23. This packet provides an initial position to the GPS receiver in XYZ coordinates. However, the GPS receiver assumes the position provided in this packet to be accurate. This packet is used for satellite acquisition aiding in systems where another source of position is available. For acquisition aiding, the position provided by the user to the GPS receiver in this packet should be accurate to a few kilometers. For high-accuracy time transfer, position should be accurate to a few meters.

Table A.17 Command Packet 0x31 Data Format

Byte	Item	Type	Units
0-3	X-axis	Single	Meters
4-7	Y-axis	Single	Meters
8-11	Z-axis	Single	Meters

Command Packet 0x32 - Accurate Initial Position, (Latitude, Longitude, Altitude)

This packet is identical in content to Packet 0x2B. This packet provides the GPS receiver with an accurate initial position in latitude, longitude, and altitude coordinates. However, the GPS receiver assumes the position provided in this packet to be accurate. This packet is used for satellite acquisition aiding in systems where another source of position is available. For acquisition aiding, the position provided by the user to the GPS receiver in this packet should be accurate to a few kilometers. For high-accuracy time transfer, position should be accurate to a few meters.

Table A.18 Command Packet 0x32 Data Format

Byte	Item	Type	Units
0-3	Latitude	Single	Radians, North
4-7	Longitude	Single	Radians, East
8-11	Altitude	Single	Meters

Command Packet 0x35 - Set Request I/O Options

This packet requests the current I/O options and allows the I/O options to be set. To request the options settings without any changes, send the packet with no data bytes. To change the options settings, include four data bytes with the values. The I/O options, their default settings, and the byte values for all possible configurations are shown below.

The Set/Request I/O options are stored in battery-backed memory. To store them in non-volatile RAM (Flash), use the 0x8E-26 command. The GPS receiver returns Packet 0x55.

These abbreviations are used in the following table:

- ALT Altitude
- ECEF Earth-centered, Earth-fixed
- XYZ Cartesian Coordinates
- LLA Latitude, Longitude, Altitude
- HAW Height Above Ellipsoid
- WGS-84 Earth Model (ellipsoid)
- MSL Geoid Mean Sea Level
- UTC Coordinated Universal Time

Table.19 Command Packets 0x35 and 0x55 Data Descriptions

Byte	Bit	Item	Type	Value	Definition
Position					
0	0 (LSB)	XYZ ECEF	Bit	0	XYZ ECEF output off
				1	XYZ ECEF output on
	1	LLA Output	Bit	0	LLA output off
				1	LLA output on
	2	LLS ALT Output	Bit	0	HAE (See Note)
				1	MSL geoid
	3	ALT input	Bit	0	HAE (See Note)
1				MSL geoid	
4	Precision-of-position output	Bit	0	Send single-precision packet	
			1	Send double-precision packet	
5	Super Packet Output	Bit	0	Output no Super Packets	
			1	Output all enabled Super Packets	
6-7		Reserved			
Velocity					
1	0	XYZ ECEF	Bit	0	XYZ ECEF output off
				1	XYZ ECEF output on
	1	ENU Output	Bit	0	ENU output off
1				ENU output on	
2-7		Reserved			
Timing					
2	0	Time Type	Bit	0	GPS Time
				1	UTC
1-4		Reserved			

Table.19 Command Packets 0x35 and 0x55 Data Descriptions

Byte	Bit	Item	Type	Value	Definition
	5-6	PPS Mode	Bits	00 01 10 11	Always On Fix Based Always Off Reserved
	7	Reserved			
Auxiliary/Pseudo Range Measurements					
3	0	Raw Measuring	Bit	0 1	Raw measurements off Raw measurements on
	1	Raw/Filtered	Bit	0 1	Raw PR's in 5A Filtered PR's in 5A
	2	Reserved			
	3	Output dB Hz instead of AMU	Bit	0 1	Output AMUs Output dB Hz
	4-7	Reserved			

Notes – In the current version of the Lassen iQ GPS, the input and output HAE altitude is in the WGS-84 datum.

Packet 8E must be used to specify which Super Packet is to be output.

The Lassen iQ GPS supports automatic output of 0x5A messages for backwards compatibility with older TSIP applications.

Command Packet 0x37 - Request Status and Values of Last Position and Velocity

This packet requests information regarding the last position fix and is only used when the receiver is not automatically outputting positions. The GPS receiver returns Report Packet 0x57 followed by the position/velocity packets specified in Command Packet 0x35.

Command Packet 0x38 - Request/Load Satellite System Data

This packet requests current satellite data (almanac, ephemeris, etc.) or permits loading initialization data from an external source (for example, by extracting initialization data from an operating GPS receiver unit via a data logger or computer and then using that data to initialize a second GPS receiver unit). The GPS receiver returns Packet 0x58. (Note that the GPS receiver can initialize itself without any data from the user; it merely requires more time.)

To request data without loading data, use only bytes 0 through 2; to load data, use all bytes. Before loading data, observe the caution notice below. The data formats are located in Report Packet 0x58.

Table A.20 Command Packet 0x38 Data Formats

Byte	Item	Type	Value	Definition
0	Operation	UINT8	1 2	Request data from Lassen iQ GPS receiver; Load data into Lassen iQ GPS receiver
1	Type of data	UINT8	2 3 4 5 6	Almanac Health page, T_oa, WN_oa Ionosphere UTC Ephemeris
2	Sat PRN#	UINT8	0 1 - 32	Data that is not satellite - ID specific Satellite PRN number
3	Length (n)	UINT8		Number of bytes of data to be loaded
4 to n+3	Data	UINT8		Satellite data

Warning – Proper structure of satellite data is critical to Lassen iQ GPS receiver operation. Requesting data is not hazardous; Loading data improperly is hazardous. Use this packet only with extreme caution. The data should not be modified in any way. It should only be retrieved and stored for later download.

Command Packet 0x3C - Request Current Satellite Tracking Status

This packet requests the current satellite tracking status. The GPS receiver returns Packet 0x5C if data is available.

Table A.21 Command Packet 0x3C Data Format

Byte	Item	Type	Value	Definition
0	Satellite #	UINT8	0 1 - 32	All satellites in the current tracking set desired satellite

Report Packet 0x41 - GPS Time

This packet provides the current GPS time of week and the week number. The GPS receiver sends this packet in response to Packet 0x21 and during an automatic packets update cycle. Update cycles occur approximately every 5 seconds. The data format is shown below.

Table A.22 Report Packet 0x41 Data Formats

Byte	Item	Type	Units
0-3	GPS time of week	Single	seconds
4-5	Extended GPS week number	INT16	weeks
6-9	GPS UTC offset	Single	seconds

Note – UTC time lags behind GPS time by an integer number of seconds; $UTC = (GPS\ time) - (GPS\ UTC\ offset)$.

Warning – GPS week number runs from 0 to 1023 and then cycles back to week #0. week # 0 began January 6, 1980. The first cycle back to week #0 was on August 22, 1999. The extended GPS week number however, does not cycle back to 0. For example: the week # for August 22, 1999 = 1024; the Week # for April 1, 2002 = 1160.

The seconds count begins with “0” each Sunday morning at midnight GPS time. A negative indicated time-of-week indicates that time is not yet known; in that case, the packet is sent only on request. The following table shows the relationship between the information in Packet 0x41, and the Packet 0x46 status code.

Table A.23 Packets 0x41 and 0x46 Status Code Relationships

Approximate Time Accuracy	Time Source	Sign (TOW)	Packet 46 Status Code
none	no time at all	-	0x01
unknown	approximate time from real-time clock or Packet 2E	+	0x01
20-50 msec + clock drift	time from satellite	+	0x02 - 0x0C
full accuracy	time from GPS solution	+	0x00

***Note** – Before using the GPS time from Packet 0x41, verify that the Packet 0x46 status code is 00 (“Doing position fixes”). This will ensure the most accurate GPS time.*

Report Packet 0x42 - Single-Precision Position Fix, XYZ ECEF

This packet provides current GPS position fix in XYZ ECEF coordinates. If the I/O “position” option is set to XYZ ECEF (byte 0: bit 0, Packet 0x35) and the I/O Precision-of-Position Output (byte 0: bit 4, Packet 0x35) is set to single-precision, then the GPS receiver sends this packet each time a fix is computed. The data format is shown below.

Table A.24 Report Packet 0x42 Data Formats

Byte	Item	Type	Units
0-3	X	Single	meters
4-7	Y	Single	meters
8-11	Z	Single	meters
12-15	Time-of-fix	Single	seconds

The time-of-fix is in GPS time or UTC as selected by the I/O “timing” option. Packet 83 provides a double-precision version of this information.

Report Packet 0x43 - Velocity Fix, XYZ ECEF

This packet provides current GPS velocity fix in XYZ ECEF coordinates. If the I/O velocity option is set to XYZ ECEF (byte 1, bit 0, Packet 0x35), then the GPS receiver sends this packet each time a fix is computed. The data format is shown below.

Table A.25 Report Packet 0x43 Data Formats

Byte	Item	Type	Units
0-3	X velocity	Single	meters/second
4-7	Y velocity	Single	meters/second
8-11	Z velocity	Single	meters/second
12-15	bias rate	Single	meters/second
16-19	time-of-fix	Single	seconds

The time-of-fix is in GPS time or UTC as selected by the I/O “timing” option (byte 2, bit 0, Packet 0x35).

Report Packet 0x45 - Software Version Information

This packet provides information about the version of software in the Navigation and Signal Processors. The GPS receiver sends this packet after power-on and in response to Packet 0x1F.

Table A.26 Report Packet 0x45 Data Formats

Byte	Item	Type
0	Major version number	UINT8
1	Minor version number	UINT8
2	Month	UINT8
3	Day	UINT8
4	Year number minus 1900	UINT8
5	Major revision number	UINT8
6	Minor revision number	UINT8
7	Month	UINT8
8	Day	UINT8
9	Year number minus 2000	UINT8

The first 5 bytes refer to the Navigation Processor and the second 5 bytes refer to the Signal Processor.

Report Packet 0x46 - Health of Receiver

This packet provides information about the satellite tracking status and the operational health of the receiver. The receiver sends this packet after power-on or software-initiated resets, in response to Packet 0x26 and, every five seconds. Packet 0x4B is always sent along with this packet.

Note – If receiver status changes between five second outputs, no notification is given until the next cycle.

Table A.27 Report Packet 0x46 Data Formats

Byte	Bit	Item	Type	Value	Definition
0		Status code	UINT8	0x00 0x01 0x02 0x03 0x08 0x09 0x0A 0x0B 0x0C	Doing position fixes Don't have GPS time yet Need initialization (0=normal, 1=shutdown due to RF initialization timeout) PDOP is too high No usable satellites Only 1 usable satellite Only 2 usable satellites Only 3 usable satellites The chosen satellite is unusable
1	0	Battery backup	Bit	0 1	OK BBRAM was not available at start-up
1	4	Antenna feedline fault	Bit	0 1	OK Short or open detected
1	5	Type of fault	Bit	0 1	Open detected Short detected

The error codes in Byte 1 of Packet 0x46 are encoded into individual bits within the byte. The bit positions are shown below.

Note – After status is detected, it's bit remains set until the receiver is reset.

Report Packet 0x47 - Signal Levels for all Satellites

This packet provides received signal levels for all satellites currently being tracked or on which tracking is being attempted (i.e., above the elevation mask and healthy according to the almanac). The receiver sends this packet only in response to Packet 0x27. The data format is shown below.

Table A.28 Report Packet 0x47 Data Formats

Byte	Item	Type
0	Count	UINT8
1	Satellite number 1	UINT8
2- 5	Signal level 1	Single
6	Satellite number 2	UINT8
7-10	Signal level 2	Single
(etc.)	(etc.)	(etc.)

Up to 8 satellite number/signal level pairs may be sent, indicated by the count field. Signal level is normally positive. If it is zero then that satellite has not yet been acquired. If it is negative then that satellite is not currently in lock. The absolute value of signal level field is the last known signal level of that satellite.

Note – The signal level provided in this packet is a linear measurement of the signal strength after correlation or de-spreading. Units, either AMU or dBHz, are controlled by Packet 0x35.

Report Packet 0x4A - 20 Byte Format

This packet provides current GPS position fix in LLA (latitude, longitude, and altitude) coordinates. If the I/O Position option is set to LLA and the I/O Precision-of-Position Output is set to single-precision (all controlled by Packet 35), then the receiver sends this packet each time a fix is computed. Command Packet 35 controls position output (XYZ or LLA) and (single or double) output precision. The data format is shown in below.

Table A.29 Report Packet 0x4A Data Formats

Byte	Item	Type	Units
0-3	Latitude	Single	radians; + for north, - for south
4-7	Longitude	Single	radians; + for east, - for west
8-11	Altitude	Single	meters (HAE or MSL)
2-15	Clock Bias	Single	meters
6-19	Time-of-Fix	Single	seconds (GPS or UTC)

The default altitude conversion is WGS-84. Altitude is referred to the datum ellipsoid or the MSL Geoid, depending on which I/O “LLA altitude” option is selected. The time-of-fix is in GPS time or UTC, depending on which I/O “timing” option is selected. This packet also is sent at start-up with a negative time-of-fix to report the current known position. Packet 0x84 provides a double-precision version of this information

Warning – When converting from radians to degrees, significant and readily visible errors will be introduced by use of an insufficiently precise approximation for the constant PI). The value of the constant PI as specified in ICD-GPS-200 is 3.1415926535898.

Report Packet 0x4A - 9 Byte Format

Report Packet 0x4A is also sent in response to the setting or requesting of the Reference Altitude Parameters using Command Packet 0x2A. These parameters can be used in the Manual 2-D mode.

Reference Altitude

The altitude used for manual 2-D positions if the altitude flag is set. Altitude is in units of HAE WGS-84 or MSL depending on the selected I/O options set for positioning with Command Packet 35.

Altitude Flag

A flag that determines whether or not the Reference Altitude will be used. If set, it will be used. If cleared, altitude hold (last 3-D altitude) will be used. The data format is shown in the following table.

Table A.30 Reference Altitude

Byte	Item	Type	Units
0-3	Reference Altitude	Single	Meters
4-7	Reserved	Single	
8	Altitude flag	UINT8	

Report Packet 0x4B - Machine/Code ID and Additional Status

The receiver transmits this packet in response to packets 0x25 and 0x26 and following a change in state. In conjunction with Packet 0x46, “health of receiver,” this packet identifies the receiver and may present status messages. The machine ID can be used by equipment communicating with the receiver to determine the type of receiver to which the equipment is connected. Then the interpretation and use of packets can be adjusted accordingly.

Table A.31 Report Packet 0x4B Data Formats

Byte	Item	Type/	Definition
0	Machine ID	UINT8	Receiver dependent
1	Status 1	UINT8	See Table A.32
2	Status 2	UINT8	Bit 0 = Super packets supported

The status codes are encoded into individual bits within the bytes. The bit positions and their meanings are listed in the table below.

Table A.32 Report Packet 0x4B Bit Positions and Descriptions

Status 1 Bit Positions	Meaning if bit value = 1
0 (LSB)	Not used
1	Real-time Clock was not available at power-up.
2	Not used
3	The almanac stored in the receiver is not complete and current.
4-7	Not used

Report Packet 0x4D - Oscillator Offset

This packet provides the current value of the receiver master oscillator offset in Hertz at carrier. This packet contains one single precision number. The receiver sends this packet in response to Packet 0x2D. The permissible offset varies with the receiver unit.

Report Packet 0x4E - Response to Set GPS Time

Indicates whether the receiver accepted the time given in a Set GPS time packet. the receiver sends this packet in response to Packet 0x2E. This packet contains one byte.

Table A.33 Report Packet 0x4E Data Formats

Value	Meaning
ASCII "Y"	The receiver accepts the time entered via Packet 2E. The receiver has not yet received the time from a satellite.
ASCII "N"	The receiver does not accept the time entered via Packet 2E. The receiver has received the time from a satellite and uses that time. The receiver disregards the time in Packet 0x 2E.

Report Packet 0x55 - I/O Options

These abbreviations apply to the following table: ALT (Altitude), ECEF (Earth-centered, Earth-fixed), XYZ (Cartesian coordinates), LLA (latitude, longitude, altitude), HAE (height above ellipsoid), WGS-84 (Earth model (ellipsoid)), MSL geoid (Earth (mean sea level) mode), and UTC (coordinated universal time).

Table A.34 Command Packets 0x55 and 0x35 Data Descriptions

Byte	Bit	Item	Type	Value	Definition
Position					
0	0	XYZ ECEF	Bit	0 1	XYZ ECEF output off XYZ ECEF output on
0	1	LLA Output	Bit	0 1	LLA output off LLA output on
0	2	LLA ALT Output	Bit	0 1	HAE (WGS-84 datum) MSL geoid
0	3	ALT input	Bit	0 1	HAE (WGS-84 datum). MSL geoid
0	4	Precision-of-position output	Bit	0 1	Send single-precision packet. Send double-precision packet.
0	5	Super Packet Output	Bit	0 1	Output no Super Packets. Output all enabled Super Packets.
0	6-7	reserved			
Velocity					
1	0	XYZ ECEF	Bit	0 1	XYZ ECEF output off XYZ ECEF output on
1	1	ENU output	Bit	0 1	ENU output off ENU output on
1	2-7	reserved			

Table A.34 Command Packets 0x55 and 0x35 Data Descriptions (Continued)

Byte	Bit	Item	Type	Value	Definition
Timing					
2	0	Time Type	Bit	0 1	GPS time UTC
2	1-7	reserved			
Auxiliary / Range Measurements					
3	0	Raw measuring	Bit	0 1	Raw measurements off Raw measurements on
3	1	Raw / Filtered	Bit	0 1	Raw PR's in 0x5A Filtered PR's in 0x5A
3	2	reserved			
3	3	Output dB Hz instead of AMU	Bit	0 1	Output dB Hz Output AMU's
3	4-7	reserved			

Notes – See the associated superpacket output, described later in this appendix. Packet 8E must be used to specify which superpacket is to be output.

Automatic output of 0x5A raw measurement messages is supported in the Lassen iQ GPS receiver for backwards compatibility with older TSIP applications.

Report Packet 0x56 - Velocity Fix, East-North-Up (ENU)

If East-North-Up (ENU) coordinates have been selected for the I/O “velocity” option (see Packet 0x35), the receiver sends this packet under the following conditions:

- Each time that a fix is computed
- In response to Packet 0x37 (last known fix)

The data format is shown below.

Table A.35 Report Packet 0x56 Data Formats

Byte	Item	Type	Units
0-3	East Velocity	Single	m/s; + for east, - for west
4-7	North Velocity	Single	m/s; + for north, - for south
8-11	Up Velocity	Single	m/s; + for up, - for down
12-15	Clock Bias Rate	Single	m/s
16-19	Time-of-Fix	Single	seconds (GPS or UTC)

The time-of-fix is in GPS or UTC time as selected by the I/O “timing” option.

Report Packet 0x57 - Information About Last Computed Fix

This packet provides information concerning the time and origin of the previous position fix. The receiver sends this packet, among others, in response to Packet 0x37. The data format is shown below.

Table A.36 Report Packet 0x57 Data Formats

Byte	Item	Type	Units	Byte 0 Value/Velocity
0	Source of information	UINT8	--	00 temporary no fix 01 good current fix
1	Mfg. diagnostic	UINT8	--	
2-5	Time of last fix	Single	seconds, GPS time	
6-7	Week of last fix	INT16	weeks, GPS time	

Report Packet 0x58 - Satellite System Data/Acknowledge from Receiver

This packet provides GPS data (almanac, ephemeris, etc.). The receiver sends this packet in response to Packet 0x38 (acknowledges the loading of data). The data format is shown below.

Table A.37 Report Packet 0x58 Data Formats

Byte	Item	Type	Value	Definition
0	Operation	UINT8	1 2	Request data from receiver; Load data into receiver
1	Type of data	UINT8	2 3 4 5 6	Almanac Health page, T_oa, WN_oa Ionosphere UTC Ephemeris
2	Sat PRN#	UINT8	0 1 - 32	Data that is not satellite - ID specific satellite PRN number
3	Length (n)	UINT8		Number of bytes of data to be loaded
4 to n+3	Data			

Note – If data is not available, byte 3 is set to 0 and “no” data is sent.

The binary almanac, health page, and UTC data streams are similar to Report Packets 0x40, 0x49, and 0x4F respectively, but these reports are preferred. To get ionosphere or ephemeris, this report must be used.

Note – Ephemeris cannot be loaded into Lassen iQ GPS receiver.

Table A.38 Report Packet 0x58 Almanac Data

Byte	Item	Type	Definition / ICD-GPS-200
4	t_oa_raw	UINT8	Sec 20.3.3.5.1.2
5	SV_HEALTH	UINT8	Sec 20.3.3.5.1.2
6-9	e	Single	Sec 20.3.3.5.1.2
10-13	t_oa	Single	Sec 20.3.3.5.1.2

Table A.38 Report Packet 0x58 Almanac Data

14-17	i_o	Single	Sec 20.3.3.5.1.2
18-21	OMEGADOT	Single	Sec 20.3.3.5.1.2
22-25	sqrt_A	Single	Sec 20.3.3.5.1.2
26-29	OMEGA_0	Single	Sec 20.3.3.5.1.2
30-33	omega	Single	Sec 20.3.3.5.1.2
34-37	M_0	Single	Sec 20.3.3.5.1.2
38-41	a_f0	Single	Sec 20.3.3.5.1.2
42-45	a_f1	Single	Sec 20.3.3.5.1.2
46-49	Axis	Single	Sec 20.3.3.5.1.2
50-53	n	Single	Sec 20.3.3.5.1.2
54-57	OMEGA_n	Single	Sec 20.3.3.5.1.2
58-61	ODOT_n	Single	Sec 20.3.3.5.1.2
62-65	t_zc	Single	Sec 20.3.3.5.1.2. see Note 2.
66-67	weeknum	INT16	Sec 20.3.3.5.1.2
68-69	wn_oa	INT16	Sec 20.3.3.5.1.2

Note 1 – All angles are in radians.

Note 2 – If data is not available, t_zc is set to -1.0.

Table A.39 Report Packet 0x58 Almanac Health Data

Byte	Item	Type	Definition/ ICD-GPS-200
4	week # for health	UINT8	Sec 20.3.3.5.1.3
5-36	SV_health	UINT8	Sec 20.3.3.5.1.3
37	t_oa for health	UINT8	Sec 20.3.3.5.1.3
38	current t_oa	UINT8	units = seconds/2048
39-40	current week #	INT16	

Table A.40

Byte	Item	Type	Definition / IDC-GPS-200
4-11	---	---	not used
12-15	alpha_0	Single	Sec 20.3.3.5.1.9
16-19	alpha_1	Single	Sec 20.3.3.5.1.9
20-23	alpha_2	Single	Sec 20.3.3.5.1.9
24-27	alpha_3	Single	Sec 20.3.3.5.1.9
28-31	beta_0	Single	Sec 20.3.3.5.1.9
32-35	beta_1	Single	Sec 20.3.3.5.1.9
36-39	beta_2	Single	Sec 20.3.3.5.1.9
40-43	beta_3	Single	Sec 20.3.3.5.1.9

Table A.41

Byte	Item	Type	Definition / IDC-GPS-200
4-16	---	---	not used
17-24	A_0	Double	Sec 20.3.3.5.1.8
25-28	A_1	Single	Sec 20.3.3.5.1.8
29-30	delta_t_LS	Integer	Sec 20.3.3.5.1.8
31-34	t_ot	Single	Sec 20.3.3.5.1.8
35-36	WN t	Integer	Sec 20.3.3.5.1.8
37-38	WN_LSF	Integer	Sec 20.3.3.5.1.8
39-40	DN	Integer	Sec 20.3.3.5.1.8
41-42	delta_t_LSF	Integer	Sec 20.3.3.5.1.8

Table A.42

Byte	Item	Type	Definition / IDC -GPS-200
4	sv_number	UINT8	SV PRN number
5-8	t_ephem	Single	time of collection
9-10	weeknum	INT16	Sec 20.3.3.3, Table 20-I

Table A.42 (Continued)

Byte	Item	Type	Definition / IDC -GPS-200
11	codeL2	UINT8	Sec 20.3.3.3, Table 20-I
12	L2Pdata	UINT8	Sec 20.3.3.3, Table 20-I
13	SVacc_raw	UINT8	Sec 20.3.3.3, Table 20-I
14	SV_health	UINT8	Sec 20.3.3.3, Table 20-I
15-16	IODC	INT16	Sec 20.3.3.3, Table 20-I
17-20	T_GD	Single	Sec 20.3.3.3, Table 20-I
21-24	t_oc	Single	Sec 20.3.3.3, Table 20-I
25-28	a_f2	Single	Sec 20.3.3.3, Table 20-I
29-32	a_f1	Single	Sec 20.3.3.3, Table 20-I
33-36	a_f0	Single	Sec 20.3.3.3, Table 20-I
37-40	SVacc	Single	Sec 20.3.3.3, Table 20-I
41	IODE	UINT8	Sec 20.3.3.4
42	fit_interval	UINT8	Sec 20.3.3.4
43-46	C_rs	Single	Sec 20.3.3.4
47-50	delta_n	Single	Sec 20.3.3.4
51-58	M_0	Double	Sec 20.3.3.4
59-62	C_uc	Single	Sec 20.3.3.4, radians
63-70	e	Double	Sec 20.3.3.4
71-74	C_us	Single	Sec 20.3.3.4, radians
75-82	sqrt_A	Double	Sec 20.3.3.4
83-86	t_oe	Single	Sec 20.3.3.4
87-90	C_ic	Single	Sec 20.3.3.4, radians
91-98	OMEGA_0	Double	Sec 20.3.3.4
99-102	C_is	Single	Sec 20.3.3.4, radians
103-110	i_0	Double	Sec 20.3.3.4
111-114	C_rc	Single	Sec 20.3.3.4

Table A.42 (Continued)

Byte	Item	Type	Definition / IDC -GPS-200
115-122	omega	Double	Sec 20.3.3.4
123-126	OMEGADOT	Single	Sec 20.3.3.4
127-130	IDOT	Single	Sec 20.3.3.4
131-138	Axis	Double	$= (\text{sqrt_A})^2$
139-146	n	Double	derived from delta_n
147-154	r1me2	Double	$= \text{sqrt}(1.0-e^2)$
155-162	OMEGA_n	Double	derived from OMEGA_0, OMEGADOT
163-170	ODOT_n	Double	derived from OMEGADOT

Note – All angles are in radians.

Report Packet 0x5C - Satellite Tracking Status

This packet provides tracking status data for a specified satellite. Some of the information is very implementation-dependent and is provided mainly for diagnostic purposes. The receiver sends this packet in response to Packet 0x3C. The data format is shown below.

Table A.43 Report Packet 0x5C Data Formats

Byte	Bit	Item	Type	Value	Definition
0		Satellite PRN number	UINT8	number 1 - 32	
1	0-2	reserved	Bits	reserved	
1	3-7	Channel	Bits	0-11	
2		Acquisition flag	UINT8	0 1 2	Never acquired Acquired Re-opened search

Table A.43 Report Packet 0x5C Data Formats (Continued)

Byte	Bit	Item	Type	Value	Definition
3		Ephemeris flag	UINT8	0 1 3 19 51	Flag not set Ephemeris is decoded Ephemeris is decoded and healthy Ephemeris is decoded, good and used in the current position fix Ephemeris is decoded, good, used in the fix, and a DGPS correction is available (only relevant if DGPS is enabled in the firmware)
4-7		Signal level	Single	Same as in Packet 0x47	
8-11		GPS time of last measurement	Single	<0 >0	No measurements have been taken. Center of the last measurement taken from this satellite.
12-15		Elevation	Singles	radians	Approximate elevation of this satellite above the horizon. Updated about every 15 sec.s. Used for searching and computing measurement correction factors.
16-19		Azimuth	Single	radians	Approximate azimuth from true north to this satellite. Updated typically about every 3 to 5 minutes. Used for computing measurement correction factors.
20-23		reserved	UINT8	0	

Command Packet 0x60 - Type 1 Differential GPS Corrections

This packet provides the Lassen iQ GPS with differential corrections from RTCM SC-104 record types 1 and 9, in the TSIP format. There is no response to this packet. If bit 6 is set, the corrections are as in RTCM Type 9 records. The data format is shown below.

Table A.44 Command Packet 0x60 Data Formats

Byte	Bit	Item	Type	Value	Definition
0-1		Modified z-count	UINT16	0-5999	.6 SEC
2		Station health	UINT 8	--	
3	0-5	Number of SVs in packet	Bits	0-31	0-5
3	6	Type 9 flag	Bit	0 1	type 1 Type 9
3	7	Version 2 flag	Bit	1	must be set

The next 5 bytes are repeated as a group for each satellite. The SV PRN and scale factor contains the SV PRN in the lower 5 bits, and the scale factor in the upper 3 bits. Range corrections are scaled by 0.02 meters times 2 raised to the scale factor power. Range-rate corrections are scaled by 0.0002 meters per second times 2 raised to the scale factor power. The data format is shown below.

Table A.45 Command Packet 0x60 Data Formats

Byte	Bit	Item	Type	Value	Definition
4+ (N*5)	0-4	SV PRN		0-31	"0" is SV 32
4+ (N*5)	5-7	Scale factor		0 4 7	Low scale factor (.02m, .002 m/s) High scale factor (.32m, .032 m/s) Correction not usable
5+ (N*5)		Number of SVs in packet	Bits		RTCM-104
7+ (N*5)		Type 9 flag	Bit		RTCM-104
8+ (N*5)		Version 2 flag	Bit		

Command Packet 0x62 - Set/Request Differential Position Fix Mode

Note – This command packet has been replaced by command packet 0xBB. Although the Lassen iQ GPS retains compatibility with this command, it is recommended that you use the 0xBB command packet to set the Differential Fix Mode.

This packet requests the Differential Position Fix Mode of the GPS receiver. A single data byte is sent. To request report packet 0x82, the data byte is set to 0xFF.

Command Packet 0x65 - Set/Request Differential Position Fix Mode

This packet requests the status of differential corrections for a specific satellite or for all satellites for which data is available. This packet contains only one byte specifying the PRN number of the desired satellite or zero to request all available. The response is a packet 0x85 for each satellite if data is available. If the receiver has not valid data for any satellite, no reply will be sent.

Note – TSIP packet 0x65 is not functional in the Lassen iQ GPS firmware release 1.10.

Report Packet 0x6D - All-In-View Satellite Selection

This packet provides a list of satellites used for position fixes by the GPS receiver. The packet also provides the PDOP, HDOP, and VDOP of that set and provides the current mode (automatic or manual, 3-D or 2-D). This packet has variable length equal to $16+nSVs$ where “nSVs” is the number of satellites used in the solution.

The GPS receiver sends this packet in response to Packet 0x24. The data format is shown below.

Table A.46 Report Packet 0x6D Data Formats

Byte	Bit	Item	Type	Value	Definition
0	0-2	Dimension	UINT8	3 4	2D 3D
0	3			0 1	Auto Manual
0	4-7			-	nSVs
1-4		PDOP	Single		PDOP
5-8		HDOP	Single		HDOP
9-12		VDOP	Single		VDOP
13-16		TDOP	Single		TDOP
(16+nSVvs)		SV PRN	UINT8		

Note – The Lassen iQ GPS receiver sends this packet automatically after a position fix or every second if no position fix occurs.

Command Packet 0x69 - Set/Request Enhanced Sensitivity Mode

The Lassen iQ GPS receiver is configured at the factory with the Enhanced Sensitivity feature Off. There are several ways to turn the Enhanced Sensitivity feature on:

- The iQ_CHAT program found in the iQ Starter Kit.
- The iQ_Monitor program found in the iQ Starter Kit.
- The TSIP command packet 0x69 (receiver responds with packet 0x89).

The data format is shown below.

Table A.47 Command Packet 0x69 Data Format

Byte	Item	Type	Units	Byte 0 Value/Velocity
0	Enhanced Sensitivity Mode	Byte	0 1	Off (Standard) Enhanced
1	Reserved			

Note – A soft reset is required to make the switch to Enhanced Sensitivity effective. To permanently set the Lassen iQ GPS receiver to the Enhanced Sensitivity mode, save the setting to flash memory using TSIP command packet 8E-26.

Command Packet 0x70 - Filter Control

Trimble OEM receivers have a number of filters. Command 0x70 provides control for these filters. It returns Report 0x70. There are three filters associated with 0x70:

- Position-Velocity (PV) Filter
- Static Filter
- Altitude Filter

The Position-Velocity (PV) Filter is the main filter and is used to “soften” the effect of constellation switches on position fixes. The filter has virtually no effect on velocity output and there is no lag due to vehicle dynamics. There may be a small increase in accuracy however.

A feature of the PV filter is the “Static Filter” which engages when the receiver is moving very slowly. This feature improves accuracy in the urban environment. The static filter should be turned off for the following applications:

- Slow-moving environments such as walking or drifting with the current
- When rooftop testing of receivers for moving applications

The altitude filter is a simple averaging filter with a time constant of a few seconds. It should be left on in marine and land applications.

To query for the current settings, use Command Packet 0x70 with no databytes. To input new settings, Command Packet 0x70 is sent with four data bytes.

Table A.48 Command Packet 70 Data Formats

Byte	Item	Type	Value	Definition
0	Position Velocity Filter	UINT8	0 1	Off On
1	Static Filter	UINT8	0 1	Off On
2	Altitude Filter	UINT8	0 1	Off On
3	Reserved	UINT8	reserved	

Report Packet 0x70

This report is sent as a response to Command Packet 0x70 as either a query or a set. It contains four bytes, as shown in Table A.51.

Command Packet 0x7A

The NMEA message determines whether or not a given NMEA message will be output. If the bit for a message is set, the message will be sent every “interval” second. Use the values shown below to determine the NMEA interval and message mask. While fixes are being generated, the output order is: ZDA, GGA, GLL, VTG, GSA, GSV, RMC.

Table A.49 Command Packet 0x7A and Report Packet 0x7B Data Formats

Byte	Bit	Item	Type	Value	Definition
0		Subcode	UINT8	0	
1		Interval	UINT8	1-255	Fix interval in seconds
2		Reserved	UINT8	0	
3		Reserved	UINT8	0	
4	0	RMC	Bit	0 1	Off On
4	1-7	Reserved	Bit	0	
5	0	GGA	Bit	0 1	Off On
5	1	GLL	Bit	0 1	Off On
5	2	VTG	Bit	0 1	Off On
5	3	GSV	Bit	0 1	Off On
5	4	GSA	Bit	0 1	Off On
5	5	ZDA	Bit	0 1	Off On
5	6-7	Reserved	Bit	0	

Report Packet 0x7B

This packet provides the NMEA settings and interval.

TAIP Message Output (Packet 0x7E)

TSIP packet 0x7E is a new command added to Lassen iQ GPS for setting up the output configuration for TAIP messages. This packet expands the features similar to what have been provided by packet 0x8E-40, which can be found in some older generation Trimble receiver products. (The Lassen iQ GPS does not support the 0x8E-40 command). The settings provided by the packet can be divided into 4 groups:

1. Reporting Flags – byte 1. For information on the RM command, see Appendix A in the *Lassen iQ GPS Receiver System Designer Reference Manual*.
2. The Top-of-Hour Offset – byte 2,3. This setting applies to all eight messages included in this packet. (If different values have to be applied to each message individually, use the Time-Distance feature from TAIP protocol.)
3. Automatic Output Intervals for the 8 commonly used messages – bytes 4 - 19
4. Device ID – bytes 20-23.

This packet provides the capability to set the output frequencies for the eight commonly used messages individually. This is the same as the F<message type><output interval> command in TAIP. In contrast to packet 0x8E-40, the settings in this packet are not just for the so-called Heartbeat messages, meaning the output frequency settings are not only applied when the receiver is not generating a position fix. In practice, this packet provides a comprehensive but straightforward means to set up the TAIP output configuration. It can also be used to reset the output configuration. For example, if any of these eight messages was set up as Time-Distance mode from the TAIP protocol, this packet would reset any such message back to plain periodic output mode or no automatic output mode (frequency=0).

For customization, the settings in this packet can be stored into the Flash by either TSIP packet 0x8E-26 or TAIP command SRTSAVE_CONFIG. The flash storage commands store the latest output configuration which may be set up by either this packet or any other commands from the TAIP protocol. For example, if this packet was executed first from the TSIP protocol and then the Lassen iQ GPS was switched to TAIP protocol and the output settings were changed (e.g. changed to Time-Distance mode), or vice-versa, then the latest settings would be stored into the Flash (when the flash storage command is used).

Table.50 TAIP Packet 0 x 7E

Byte	Bit	Item	Type	Value	Definition	Default
0		Subcode	UINT8	0	Setting the packet	0
1	0	ID Flag	Bit	0/1	On/Off	0
	1	CS Flag	Bit	0/1	On/Off	1
	2	EC Flag	Bit	0/1	On/Off	1
	3	FR Flag	Bit	0/1	On/Off	1
	4	CR Flag	Bit	0/1	On/Off	0
	5-7	Reserved				
2,3		TOH	UINT16	0-3599	Top of hour offset	0
4,5		AL output period	UINT16	0-3599	Auto output period for AL (sec)	0 (see note)
6,7		CP output period	UINT16	0-3599	Auto output period for CP (sec)	0
8,9		ID output period	UINT16	0-3599	Auto output period for ID (sec)	0
10,11		LN output period	UINT16	0-3599	Auto output period for LN (sec)	0
12,13		PV output period	UINT16	0-3599	Auto output period for PV (sec)	0
14,15		ST output period	UINT16	0-3599	Auto output period for ST (sec)	0

Table.50 TAIP Packet 0 x 7E

Byte	Bit	Item	Type	Value	Definition	Default
16,17		TM output period	UINT 16	0-3599	Auto output period for TM (sec)	0
18,19		VR output period	UINT 16	0-3599	Auto output period for VR (sec)	0
20-23		Veh ID	String	See TAIP ID	Vehicle ID	"0000"

Note – 0 second period means the corresponding message is not to be output at all.

Report Packet 0x82 - Differential Position Fix Mode

This packet provides the differential position fix mode of the receiver. This packet contains only one data byte to specify the mode. The packet is sent in response to Packet 0x62 and whenever a satellite selection is made and the mode is Auto GPS / DGPS (modes 2 and 3). The receiver switches automatically between modes 2 and 3 based on the availability of differential corrections for a constellation which meets all other masks. If such a constellation is not available, then the receiver stays in its current automatic mode (2 or 3), and does not do position solutions.

Valid modes are:

- Mode 0 Differential off (Manual GPS) — The receiver does position solutions without differential corrections, even if the differential corrections are available.
- Mode 1 Differential on (Manual DGPS) — The receiver only does position solutions if valid differential correction data are available.
- Mode 2 Differential currently off (Auto DGPS) — The receiver is not receiving differential correction data for all satellites in constellation which meets all other masks, and is doing non-differential position solutions.
- Mode 3 Differential currently on (Auto DGPS) — The receiver is receiving differential correction data for all satellites in a constellation which meets all other masks, and is doing differential position solutions.

Note – The Lassen iQ GPS receiver sends this packet automatically after every position fix except when in Mode 0.

Report Packet 0x83 - Double-Precision XYZ Position Fix and Bias Information

This packet provides current GPS position fix in XYZ ECEF coordinates. If the I/O Position option is set to XYZ ECEF and the I/O Precision of Position option is set to Double (see Packet 0x35), the receiver sends this packet each time a fix is computed. The data format is shown below.

Table A.51 Report Packet 0x83 Data Formats

Byte	Item	Type	Units
0-7	X	Double	meters
8-15	Y	Double	meters
16-23	Z	Double	meters
24-31	clock bias	Double	meters
32-35	time-of-fix	Single	seconds

The time-of-fix is in GPS time or UTC, as selected by the I/O “timing” option.

Packet 42 provides a single-precision version of this information.

Report Packet 0x84 - Double-Precision LLA Position Fix and Bias Information

This packet provides current GPS position fix in LLA coordinates. If the I/O Position option is set to LLA and the Precision of Position option is set to Double (see Packet 0x35), the receiver sends this packet each time a fix is computed. The data format is shown below.

Table A.52 Report Packet 0x84 Data Formats

Byte	Item	Type	Units
0-7	latitude	Double	radians; + for north, - for south
8-15	longitude	Double	radians; + for east, - for west
16-23	altitude	Double	meters
24-31	clock bias	Double	meters
32-35	time-of-fix	Single	seconds

The time-of-fix is in GPS time or UTC, as selected by the I/O “timing” option.

Warning – When converting from radians to degrees, significant and readily visible errors will be introduced by use of an insufficiently precise approximation for the constant π (PI). The value of the constant PI as specified in ICD-GPS-200 is 3.1415926535898.

Packets 0x8E and 0x8F - Superpacket

See page 156 for information on Packets 0x8E and 0x8F.

Command Packet 0x89 - Set/Request Enhanced Sensitivity Mode

The Lassen iQ GPS receiver is configured at the factory with the Enhanced Sensitivity feature Off. There are several ways to turn the Enhanced Sensitivity feature On:

- The iQ_CHAT program found in the iQ Starter Kit.
- The iQ_Monitor program found in the iQ Starter Kit.
- The TSIP command packet 0x69 (receiver responds with packet 0x89).

The data format is shown below.

Table A.53 Command Packet 0x69 Data Format

Byte	Item	Type	Units	Byte 0 Value/Velocity
0	Current Enhanced Sensitivity	Byte	0 1	Off (Standard) On (Enhanced)
1	Enhanced Sensitivity Mode after reset	Byte	0 1	Off (Standard) On (Enhanced)

***Note** – A soft reset is required to make the switch to Enhanced Sensitivity effective. To permanently set the Lassen iQ GPS receiver to the Enhanced Sensitivity mode, save the setting to flash memory using TSIP command packet 8E-26.*

Command Packet 0xBB - Navigation Configuration

In query mode, Packet 0xBB is sent with a single data byte and returns Report Packet 0xBB.

Note – This Command Packet replaces Packets 0x2C, 0x62, 0x75, and 0x77.

Table A.54 Command Packet 0xBB Query Mode Data Format

Byte #	Item	Type	Value	Definition	Default
0	Subcode	UINT8	0x00	Query mode	

TSIP Packet 0xBB is used to set GPS Processing options. The table below lists the individual fields within the 0xBB Packet.

Table A.55 Command and Report Packet 0xBB Field Descriptions

Byte #	Item	Type	Value	Definition	Default
0	Subcode	UINT8	0x00	Query mode	0x03
1	Operating Dimension	UINT8	0 3 4	Automatic (2D/3D) Horizontal (2D) Full Position (3D)	Automatic
2	DGPS Mode	UINT8	0 1 2 or 3	DGPS Off DGPS Only DGPS Auto	DGPS Auto
3	Dynamics Code	UINT8	1 2 3 4	Land Sea Air Stationary	Land
4	Reserved				
5-8	Elevation Mask	Single	0.0 - 1.57 (radian)	Lowest satellite elevation for fixes	0.0873 (5 ⁰)
9-12	AMU Mask	Single	0-25 (AMU)	Minimum signal level for fixes	2.0
13-16	DOP Mask	Single	0.2-100	Maximum DOP for fixes	12.0

Table A.55 Command and Report Packet 0xBB Field Descriptions (Continued)

Byte #	Item	Type	Value	Definition	Default
17-20	DOP Switch	Single	0.2-100	Selects 2D/3D mode	6.0
21	DGPS Age Limit	UINT8	2-90 (seconds)	Maximum time to use a DGPS correction (seconds)	30
22-39	Reserved				

Command Packet 0xBC - Protocol Configuration

TSIP Packet 0xBC is used to query the port characteristics. In query mode, Packet 0xBC is sent with a single data byte and returns Report Packet 0xBC. (See Table A.4 for information on saving the settings to non-volatile memory.)

TSIP Packet 0xBC is used to set the communication parameters on Port 1. The table below lists the individual fields within the Packet 0xBC and provides query field descriptions.

The BC command settings are retained in battery-backed RAM.

Table A.56 Command Packet 0xBC Port Characteristics

Byte	Bit	Item	Type	Value	Definition
0		Port to Set	UINT 8	0 1 0xFF	Port 1 Port 2 Current port
1		Input Baud Rate	UINT 8	2 3 4 5 6 7 8 9	Reserved Reserved Reserved 2400 baud 4800 baud 9600 baud 19200 baud 38400 baud
2		Output Baud Rate	UINT 8	As above	As above (Note 1)
3		# Data Bits	UINT 8	2 3	7 bits 8 bits
4		Parity	UINT 8	0 1 2	None Odd Even
5		# Stop Bits	UINT 8	0 1	1 bit 2 bits
6		Flow Control	UINT 8	0	0 = none

Table A.56 Command Packet 0xBC Port Characteristics (Continued)

Byte	Bit	Item	Type	Value	Definition
7	0	TAIP	Bit	0	Off
				1	On
	1	TSIP input	Bit	0 1	Off On
	2	Reserved			
	3	Reserved			
	4-7	Reserved			
8	0	TAIP	Bit	0	Off
				1	On
	1	TSIP output	Bit	0	Off
				1	On
2	NMEA output	Bit	0	Off	
			1	On	
	3-7	Reserved			
9		Reserved			

Note – The Lassen iQ GPS receiver requires that the input and output baud rates be identical.

Warning – TSIP input or output must have 8 databits (byte 3).

TSIP Superpackets

Several packets have been added to the core TSIP protocol to provide additional capability for OEM receivers. In OEM Packets 0x8E and their 0x8F responses, the first data byte is a sub-code which indicates the superpacket type. For example, in Packet 0x8E-15, 15 is the sub-code that indicates the superpacket type. Therefore the ID code for OEM packets is 2 bytes long followed by the data.

Command Packet 8E-4A - Set/Request Lassen iQ GPS Cable Delay

Using this packet, you can query and control the Lassen iQ GPS cable delay characteristics. The receiver responds to a query or control command with packet 8F-4A. The packet contains 16 bytes.

Table.57 **Command Packet 8E-4A**

Byte	Item	Type	Meaning
0	Sub-packet ID	BYTE	Always 0x4A
1	Reserved		
2	Reserved		
3	Reserved		
4-11	PPS Offset of Cable Delay	DOUBLE	Seconds (default=0.0)
12-15	Reserved		

Command Packet 0x8E-20 - Request Last Fix with Extra Information

This packet requests Packet 0x8F-20 or marks it for automatic output. If only the first byte (20) is sent, an 0x8F-20 report containing the last available fix will be sent immediately. If two bytes are sent, the packet is marked/unmarked for auto report according to the value of the second byte as shown in below. 0x37 can also be used for requesting 0x8F-20 if the 0x8F-20 is scheduled for auto output.

Table A.58 Command Packet 0x8E-20 Field Descriptions

Byte	Item	Type	Definition
0	Sub-packet id	UINT8	0x20
1	Mark for Auto-report (See Packet 35 byte 0 bit 5)	UINT8	0 = do not auto-report 1 = mark for auto-report

Note – Auto-report requires that superpacket output is enabled. Refer to Command Packet 35.

Report Packet 0x8F-20 - Last Fix with Extra Information (binary fixed point)

This packet provides complete information about the current position velocity fix in a compact, fixed-length 56-byte packet. The fields are fixed-point with precision matched to the receiver accuracy. It can be used for automatic position/velocity reports. The latest fix can also be requested by 0x8E-20 or 0x37 commands. The data format is shown below.

Table A.59 Report Packet 0x8F-20 Data Formats

Byte	Bit	Item	Type	Value	Definition
0		Sub-packet id	UINT8		Id for this sub-packet (always 0x20)
1		KeyByte	UINT8		Reserved for Trimble DGPS Post-processing.
2-3		east velocity	INT16		0.005 m/s or 0.020 m/s See Note 1.
4-5		north velocity	INT16		0.005 m/s or 0.020 m/s See Note 1.
6-7		up velocity	INT16		0.005 m/s or 0.020 m/s See Note 1.
8-11		Time Of Week	UINT32		GPS Time in milliseconds
12-15		Latitude	INT32	-2^{30} to 2^{30}	WGS-84 latitude, 2^{-31} semicircle (-90° - 90°)
16-19		Longitude	UINT32	0 to 2^{32}	WGS-84 longitude, 2^{-31} semicircle (0° - 360°)
20-23		Altitude	INT32		Altitude above WGS-84 ellipsoid, mm.
24	0	Velocity Scaling		0 1	0.005 m/s ² 0.020 m/s ²
	1-7	reserved			
25		reserved			
26		Datum			Datum index + 1 0=unknown

Table A.59 Report Packet 0x8F-20 Data Formats (Continued)

Byte	Bit	Item	Type	Value	Definition
27	0	Fix Available	Bit	0	Yes
				1	No
	1	DGPS Corrected	Bit	0	No
				1	Yes
	2	Fix Dimension	Bit	0	3D
				1	2D
3	Alt Hold	Bit	0	Last 3D Altitude	
1	User-entered altitude				
4	Filtered	Bit	0	Unfiltered	
1	Filtered				
5-7	reserved				
28		NumSVs	UINT8		Number of satellites used for fix. Will be zero if no fix was available.
29		UTC Offset	UINT8		Number of leap seconds between UTC time and GPS time.
30-31		Week	INT16		GPS time of fix, weeks.
32	0-5	PRN 1	UINT8	1-32	PRN of first satellite
	6-7	reserved			
33		IODE 1	UINT8		IODE of first satellite
34	0-5	PRN 2	UINT8	1-32	PRN of second satellite
	6-7	reserved			
35		IODE 2	UINT8		IODE of second satellite
36	0-5	PRN 3	UINT8	1-32	PRN of third satellite
	6-7	reserved			
37		IODE 3	UINT8		IODE of third satellite
38	0-5	PRN 4	UINT8	1-32	PRN of fourth satellite
	6-7	reserved			

Table A.59 Report Packet 0x8F-20 Data Formats (Continued)

Byte	Bit	Item	Type	Value	Definition
39		IODE 4	UINT8		IODE of fourth satellite
40	0-5	PRN 5	UINT8	1-32	PRN of fifth satellite
	6-7	reserved			
41		IODE 5	UINT8		IODE of fifth satellite
42	0-5	PRN 6	UINT8	1-32	PRN of sixth satellite
	6-7	reserved			
43		IODE 6	UINT8		IODE of sixth satellite
44	0-5	PRN 7	UINT8	1-32	PRN of seventh satellite
	6-7	reserved			
45		IODE 7	UINT8		IODE of seventh satellite
46	0-5	PRN 8	UINT8	1-32	PRN of eighth satellite
	6-7	reserved			
47		IODE 8	UINT8		IODE of eighth satellite
48-55		Ionospheric Parameters			

Note – Velocity scale controlled by byte 24, bit 1. Overflow = 0x8000.

Command Packet 0x8E-26 - Non-Volatile Memory Storage

The 0x8E-26 command is issued with no data to cause the current settings to be saved to non-volatile memory. The 0x8F-26 report is generated after the values have been saved.

Table A.60 Command Packet 0x8E-26 Definitions

Byte #	Item	Type	Value	Definition
0	Subcode	UINT8	0x26	Save Settings

Report Packet 0x8F-26 - Non-Volatile Memory Status

This report will be issued after an 0x8E-26 command.

Table A.61 Report Packet 0x8F-26 Field Descriptions

Byte/	Item	Type	Value	Definition
0	Subcode	UINT8	0x26	Save Settings
1-4	reserved			

TSIP Tool kit User's Guide

The GPS Tool Kit program disk includes several TSIP interface programs designed to help developer's evaluate and integrate the GPS module and create GPS applications. These programs run on a PC Win95, Win98, Win2000, or WinNT platform. They are intended as a base upon which to build application specific software, so the source code in ANSI C is included for many of these programs. The GPS Tool Kit program disk includes the following programs:

32 bit Windows Applications

iQ_Monitor: is a 32 bit windows application which interfaces with a TSIP-speaking receiver through a serial port. The program accepts TSIP reports and displays them in a window with fields for position, velocity, time, receiver status and satellite track status. It allows the user to exercise some basic TSIP commands. iQ_Monitor can also log TSIP report in binary format for later translation.

DOS Programs and C Source Code

iQ_CHAT.EXE: is a 16 bit DOS-based application which interfaces with the Lassen iQ GPS receiver through a serial port. It allows the user to exercise TSIP commands, configure the Lassen iQ GPS receiver for NMEA or TAIP, and may be used to view NMEA or TAIP output. iQ_CHAT can log a TSIP report in binary format. Source code is provided.

TSIPPRNT.EXE: is a 16 bit DOS-based application which interprets a binary TSIP data stream, such as logged by iQ_CHAT or iQ_Monitor, and prints it to a file. Source code is provided.

For further information on the above programs, see the README file on the Toolkit disk.

A 32-bit Windows Application, TSIP Reader, is available from the FTP web site, <ftp://ftp.trimble.com/pub/set/embedded/bin>, that interprets binary TSIP data streams.

iQ_Monitor

iQ_Monitor requires Win95, Win98, Win2000, WinXP, or WinNT. Once the program is started, it immediately prompts for the serial port connected to the GPS receiver.

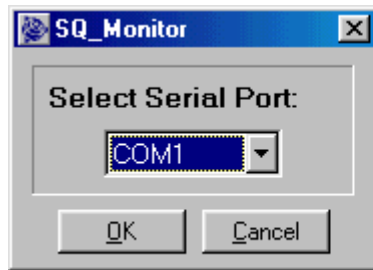

Figure B.1 iQ_Monitor - Serial Port Selection

The main window is displayed once the GPS receiver is communicating with the application. Fields with question marks “?” indicate that information is not yet available.

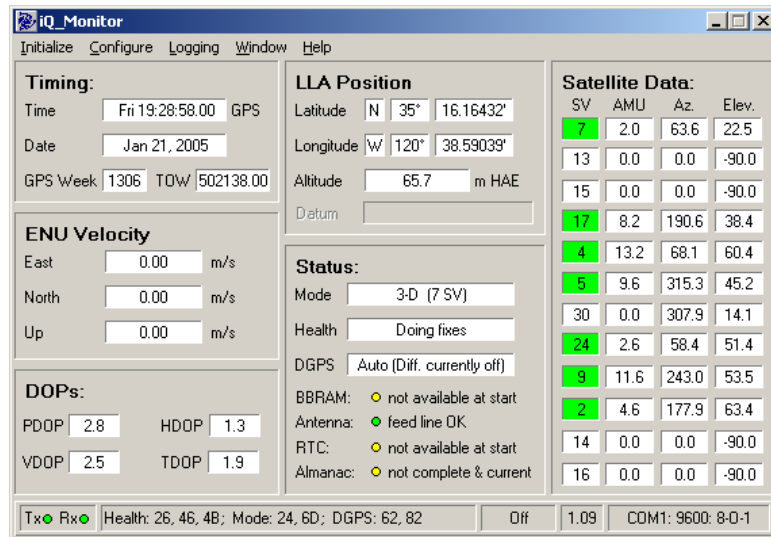

Figure B.2 iQ_Monitor - Main Window

Delta Position

iQ_Monitor displays delta position which is the difference between the current position and the initial position. The initial position can be reset at anytime by selecting [Reset Initial Position].

File Storage

iQ_Monitor provides for file storage of the raw binary TSIP stream directly from the serial port. To turn data collection on or off, use the record pull-down menu. The recorded binary data stream can be translated into an ASCII file with the program TSIPRNT or TSIPReader.

Trimble ASCII Interface Protocol (TAIP)

Trimble ASCII Interface Protocol (TAIP) is a Trimble-specified digital communication interface based on printable ASCII characters over a serial data link. TAIP was designed specifically for vehicle tracking applications but has become common in a number of other applications because of its ease of use. TAIP supports both scheduled and polled responses.

TAIP messages may be scheduled for output at a user specified rate starting on a given epoch from top of the hour. For communication robustness, the protocol optionally supports checksums on all messages. It also provides the user with the option of tagging all messages with the unit's user specified identification number (ID). This greatly enhances the functional capability of the unit in a network environment. Additionally, given the printable ASCII format of all communication, TAIP is ideal for use with mobile data terminals, modems, and portable computers. Although, receivers incorporating this protocol are shipped from the factory with a specific serial port setting, the port characteristics are fully programmable through TAIP messages.

The Lassen iQ GPS receiver supports the following TAIP messages:

Table C.1 Lassen iQ GPS Supported Messages

Message	Description
AL	Altitude/Up Velocity
AP	Auxiliary Port Characteristics
CP	Compact Position Solution
DC	Differential Corrections
ID	Identification Number
IP	Initial Position
LN	Long Navigation Message
PR	Protocol
PT	Port Characteristic
PV	Position/Velocity Solution
RM	Reporting Mode
RT	Reset Mode
ST	Status
TM	Time/Date
VR	Version Number

Note – The Lassen iQ GPS firmware version 1.10 does not support the AP and DC TAIP messages.

Message Format

All TAIP communication uses printable, uppercase ASCII characters. The interface provides the means to configure the output of various sentences in response to queries or on a scheduled basis. Each sentence has the following general format:

```
ABB{C}[:,ID=DDDD][:,*FF]<
```

where:.

Table C.2 Message Formats

Message	Description
>	Start of new message
A	Message qualifier
BB	Two character message identifier
C	Data string
DDDD	Optional 4 character vehicle ID
FF	Optional 2 character checksum
<	Delimiting character
{x}	Signifies that x can occur any number of times
[x]	Signifies that x may optionally occur once

Start of a New Message

The > character (ASCII code 62 decimal) is used to specify the start of a new sentence.

Message Qualifier

A one character message qualifier is used to describe the action to be taken on the message. The following table lists the valid qualifiers.

Table C.3 Message Format Qualifiers

Qualifier	Action
Q	Query for a single sentence (sent to GPS receiver)
R	Response to a query or a scheduled report (from the receiver)
F	Schedule reporting frequency interval in seconds
S	Enables equipment to be initialized, and sets various message types
D	Specify a minimum distance traveled and a minimum and maximum time interval for the next report

Note – All TAIP message characters must be in uppercase.

Message Identifier

A unique two character message identifier consisting of alphabetical characters is used to identify type messages. For example: PR for Protocol or VR for Version Number.

Data String

The format and length of a data string is dictated by the message qualifier and the message identifier. The data string may contain any printable ASCII character with the exception of the >, <, and ; characters. Detailed descriptions of each message format are provided in the specific message sections of this Appendix. Most messages are length sensitive and unless otherwise specified, field separators, including spaces are not used.

Vehicle ID

A vehicle identification (ID) may optionally be used in all the communications with the receiver. Each receiver in the fleet may be assigned a four character alpha-numeric ID and be forced to output that ID in all messages. The default is: ID set to 0000 and the ID Flag set to F (false). The receiver will check all incoming messages for ID. If no ID is specified, the receiver will accept the message. If the ID is included in messages but does not compare with the ID previously set, the message will be ignored. This applies even when the ID Flag is turned off.

Checksum

The checksum field provides for an optional two digit hex checksum value, which is computed as XOR of *all characters* from the beginning of the sentence up to and including the * character. If provided, the checksum is always the last element of the sentence before the message delimiter. The default mode of operation is to include checksum in sentences. The use of checksums can help in instances where the communication channel is noisy.

Example

The following message used to set the vehicle ID flag includes checksum.

```
>SRM;ID_FLAG=T;*6F<
```

In this example, the checksum (6F) was generated by XOR'ing the ASCII codes for > and S then XOR'ing that result with the ASCII code for R and so forth, up to and including the * character.

Message Delimiter

The < character signifies end of a sentence and is used as the message delimiter.

Sample PV Message

The Position/Velocity Solution (PV) message is one of the more commonly used TAIP messages and most receivers using TAIP are set by default to output the PV message once every 5 seconds.

The following analysis of a typical PV message is provided to further explain the TAIP message protocol.

```
>RPV15714+3739438-1220384601512612;ID=1234;*7F<
```

Table C.4 Sample PV Message Fields

ID	Meaning
>	Start of message delimiter
R	Response qualifier
PV	PV message identifier
15714	GPS time of day
+3739438	Latitude
-12203846	Longitude
015	Speed
126	Heading
1	Source of data
2	Age of data
;ID=1234	Vehicle ID
*7F	Checksum
<	End of message delimiter

Note – See *PV Position/Velocity Solution*, page 191, for more detail on the interpretation of this message.

Time and Distance Reporting

The 'D' message qualifier allows you to specify a minimum distance traveled as well as a minimum and maximum time interval for the next report. Units that are stationed at a fixed location can be programmed to report only when the unit moves "off station" or after a certain elapsed time since last report, but no more often than the specified minimum time interval.

The message format used with the 'D' qualifier is shown below:

```
>DAABBBBCCCCEEEEFFFF[;ID=GGGG][;*HH]<
```

The distance 'D' in the message refers to the radial distance. A message would be issued if the receiver has moved farther than a radius of 'D' away from where it was previously reported. If the accumulated distance traveled is longer than 'D' but the final location is still within the radius of 'D' (e.g. circling many times around a closed perimeter of radius smaller than 'D'), then no message would be issued.

Table C.5 Time and Distance Reporting Message Format Qualifiers

ID	Meaning
>	Start of message delimiter
D	Distance message qualifier
AA	Message to report (i.e. PV means Position Velocity message)
BBBB	Minimum time (seconds) interval between reports ($T_{interval}$)
CCCC	Report epoch (number of seconds from top of the hour)
EEEE	Delta distance (meters) from last reported distance
FFFF	Maximum time (seconds) interval between reports (T_{max})
GGGG	Optional vehicle identification number (user selected)
HH	Optional checksum
<	End of message delimiter

Note – If *BBBB* = 0, then the message output is disabled. If *FFFF* = 0, maximum time feature is disabled (the unit will only report if current position is greater than or equal to the delta distance specified in *EEEE*).

Example

When the message: >DPV0030000505000900;ID=0105< is sent to the GPS receiver, it specifies that vehicle number 105 (*GGGG* = 0105) is to report the Position Velocity message (*AA* = PV) whenever its current position differs from the previously reported position by at least 500 meters (*EEEE* = 0500), but no more often than every 30 seconds (*BBBB* = 0030) or less often than every 15 minutes (*FFFF* = 0900 seconds). The minimum and maximum time-out reports are to be issued with a 5 second offset (*CCCC* = 0005) from the top of the hour. The optional checksum was not used in this example. The square brackets, [...], shown in the format description above are used to indicate optional data. The brackets themselves are never included in the actual TAIP message string.

Latitude and Longitude Conversion

The TAIP protocol reports latitude as positive north decimal degrees and longitude as positive east decimal degrees, using the WGS-84 datum. For your application, you may wish to convert to degrees, minutes and seconds. The following example illustrates the conversion of decimal degrees to degrees, minutes and seconds.

Example

Given latitude and longitude in decimal degrees,

Latitude: +37.39438°

Longitude: -122.03846°

Convert latitude by multiplying the decimal fraction of degrees by 60 to convert to minutes,

$$0.39438 \times 60 = 23.6628 \text{ minutes}$$

Retain the integer (23) portion as the minutes then multiply the decimal fraction by 60 to convert to seconds,

$$0.6628 \times 60 = 39.768 \text{ seconds}$$

Since the sign of the latitude in this example is positive the result is,

Latitude: N 37° 23' 39.77"

The longitude is converted in the same fashion,

Longitude: W 122° 02' 18.46"

***Note** – At the earth's equator, one degree of latitude and longitude represents 68.7 miles; therefore, 0.00001 degrees represents approximately 3.6 feet or 1.1 meters. Each second represents approximately 100.76 ft. (30.7 m).*

Message Data Strings

The following table lists all the TAIP messages currently defined and comments regarding their application. The data string format of each message is described in the following pages.

Table C.6 Message Data String Descriptions

Identifier	Message Format	Frequency and Distance	Query	Response/ Report	Set
AL	Altitude/Vertical Velocity	X	X	X	X
*AP	Auxiliary Port Characteristic		X	X	X
CP	Compact Position Solution	X	X	X	X
*DC	Differential Corrections				X
ID	Vehicle ID	X	X	X	X
IP	Initial Position	X	X	X	X
LN	Long Navigation Message	X	X	X	
PR	Protocol		X	X	X
PT	Port Characteristic	X	X	X	X
PV	Position/Velocity Solution	X	X	X	X
RM	Reporting Mode	X	X	X	X
RT	Reset				X
ST	Status	X	X	X	
TM	Time/Date	X	X	X	
VR	Version Number	X	X	X	X

Notes – The Lassen iQ GPS firmware version 1.10 does not support these () TAIP messages.*

All TAIP message characters must be in uppercase.

AL Altitude/Up Velocity

Note – The first character of altitude or vertical velocity (S) is “+” or “-”.

Data String Format:

AAAA(S)BBBBB(S)CCCDE

Table C.7 Altitude/Up Velocity Data String Descriptions

Item	# of Char	Units	Format	Value
GPS Time of Day	5	Sec	AAAAA	
Altitude	6	Meter	(S)BBBBB	
Vertical Velocity	4	MPH	(S)CCC	
Fix Mode	1	n/a	D	0=2D GPS 1=3D GPS 2=2D DGPS 3=3D DGPS 6=reserved 8=reserved 9=no fix avail.
Age of Data Indicator	1	n/a	E	2=Fresh,<10 sec. 1=Old,>10 sec. 0=Not available
Total # of Characters is 17				

Altitude is above mean sea level in WGS-84. The GPS time of day is the time of fix rounded to the nearest second. This message contains data obtained from the last 3 dimensional fix and may not be current.

Note – The data in this message is to be considered invalid and should not be used, if the Age of Data Indicator is equal to 0 (signifying data not available).

AP Auxiliary Port Characteristics

Note – The Lassen iQ GPS receiver firmware version 1.10 does not support the AP TAIP message.

Data String Format:

AAAA,B,C,D,E,F

Table C.8 Auxiliary Port Characteristics Data String Descriptions

Item	# of Char	Units	Format	Value
Baud Rate	4	n/a	AAAA	9600, 4800, 2400, 1200, or 0300
# of data bits	1	n/a	B	7 or 8
# of stop bits	1	n/a	C	1 or 2
Parity	1	n/a	D	N = None O = Odd E = Even
Auxiliary Port Number	1	n/a	E	1
Reserved	1	n/a	F	0
Total number of characters is 9 (excluding commas)				

This message defines the characteristics for the auxiliary port. The auxiliary port must be the RTCM input port on differential ready receivers. The default settings of the auxiliary port are 4800 baud, 8 data bits, parity none, and 1 stop bit.

Example:

The following command will set the auxiliary port characteristics to 2400 baud, 8 data bits, 1 stop bit, and no parity. >SAP2400,8,1,N,1,0<

Notes – See the inclusion of 0 in the reserved field.

The AP command applies to receivers with dual serial ports.

The AP command requires commas between data fields.

CP Compact Position Solution

Note – The first character of latitude or longitude “(S)” is “+” or “-”.

Data String Format:

AAAAA(S)BBCCCC(S)DDDEEEEF

Table C.9 Compact Position Solution Data String Descriptions

Item	# of Char	Units	Format	Value
GPS Time of Day	5	Sec	AAAAA	
Latitude	7	Deg	(S)BBCCCC	
Longitude	8	Deg	(S)DDDEEEE	
Fix Mode	1	n/a	F	0=2D GPS 1=3D GPS 2=2D DGPS 3=3D DGPS 6=reserved 8=reserved 9=no fix avail.
Age of Data Indicator	1	n/a	G	2=Fresh,<10 sec. 1=Old,>10 sec. 0=Not available
Total number of characters is 22				

Position is in latitude (positive north) and longitude (positive east) WGS-84. The GPS time of day is the time of fix rounded to the nearest second.

Note – The data in this message is to be considered invalid and should not be used, if the Age of Data Indicator is equal to 0 (signifying that data is not available).

DC Differential Corrections

Note – The Lassen iQ GPS receiver firmware version 1.10 does not support the DC TAIP message.

The DC message provides the receiver with differential corrections from Type-1 and Type-9 RTCM-104 records. The numerical values are written out in hex format producing a two character hexadecimal number for each data byte.

Data String Format:

AAAAABBCC{DDEEEFFGG}

Table C.10 DC Differential Corrections Data String Descriptions

Item	# of Char	Type	Units	Format
Modified Z-count	4	Word	.6 sec	AAAA
Station health	2	Byte	N/A	BB
Number of SVs	2	Byte	N/A	BB
The next five bytes (10 characters) are repeated for each SV.				
SV PRN and scale factor	2	Byte	N/A	DD
Range correction	4	Word	RTCM-104	EEEE
Range-rate correction	2	Byte	RTCM-104	FF
IODE	2	Byte	N/A	GG

Units and scale factors are defined by RTCM-104, version 2. The SV PRN and scale factor contains the SV PRN in the lower 5 bits and the scale factor in the higher 3 bits. The scale factor has only three acceptable values:

- 0 Use with low scale factor
- 4 Use with high scale factor
- 7 Do not use

Range corrections are scaled by 0.02 meters for low scale factor and 0/32 m/sec for high scale factor.

Notes – The DC TAIP message is used to enclose differential corrections within the TAIP format.

The DC TAIP message used to input corrections requires only one communications channel. When the auxiliary port is used to input RTCM 104 corrections, it assumes a separate communications channel is available for broadcast and receipt of differential corrections.

The TAIP Software Toolkit does not support the DD message.

ID Identification Number

Data String Format:

AAAA

Table C.11 Identification Number Data String Descriptions

Item	# of Char	Units	Format
Vehicle ID	4	n/a	AAAA
Total number of characters is 4			

This message is used to report or set the vehicle's (or receiver's) unique, four character, alpha-numeric, user assigned ID. The default at cold start is 0000.

Example

The following message will set the vehicle ID to 101.

```
>SID0101<
```

The following is simply a response to a query for vehicle ID.

```
>RID0101<
```

Note – The receiver will always check incoming messages for ID and compare with the vehicle ID set in the receiver's memory. If no ID is included in the message, the receiver will assume a match and accept the message. If the message sent to the receiver does contain a vehicle ID but that ID does not match the ID previously set in the receiver, the message will be ignored. This process is followed even when the ID_Flag is turned off (refer to the message RM).

IP Initial Position

Data String Format:

(S)AA(S)BBB(S)CCCC

Table C.12 Initial Position Data String Descriptions

Item	# of Char	Units	Format
Initial Latitude	3	Deg	(S)AA
Initial Longitude	4	Deg	(S)BBB
Initial Altitude	5	10 meters	(S)CCCC
Total number of characters is 12			

This is a very coarse initial position that can be used to aid the receiver in obtaining its first fix. This is particularly useful with a receiver that does not have battery backup enabled. In such cases, every time the unit is powered up, it goes through a complete cold-start and it has absolutely no knowledge of where it is. Providing this message improves performance by decreasing the time to first fix and enhances the accuracy of the initial two dimensional navigation solutions by providing a reference altitude. In case of units with battery backed memory, sending this message is only helpful if the unit has moved more than 1,000 miles since its previous fix. In either case, the receiver can initialize itself appropriately without any data from the user; it merely requires more time.

Note – For all the above values, the first character (S) specifies the sign “+” or “-”.

Example:

The following message will set the initial position to 37° North, 122° West, altitude 10 meters.

```
>SIP+37-122+0001<
```

LN Long Navigation Message

Note – The first character of latitude, longitude, altitude or vertical speed (S) is “+” or “-”.

Data String Format:

AAAAA.BBB(S)CCDDDDDD(S)EEEEFFFFFF(S)GGGGGGHHII
IJ(S)KKKLMMMNOOPPPQQPPQ...PPQQRRRRRRRRRRXT

Table C.13 Long Navigation Message Data String Descriptions

Item	# of Char	Units	Format	Value
GPS Time of Day	8	Sec	AAAAA.BBB	
Latitude	10	Deg	(S)CC.DDDDDDD	
Longitude	11	Deg	(S)EEE.FFFFFFF	
Altitude above MSL	9	Ft	(S)GGGGGG.HH	
Horizontal speed	4	MPH	III.J	
Vertical speed	5	MPH	(S)KKK.L	
Heading	4	Deg	MMM.N	
Number of SVs used	2	n/a	OO	
SV ID (see note)	2	n/a	PP	
IODE (see note)	2	n/a	QQ	
Reserved	10	n/a	RRRRRRRRRR	
Fix Mode	1	n/a	X	0=2D GPS 1=3D GPS 2=2D DGPS 3=3D DGPS 6=DR 8=Degraded DR 9=No fix avail.
Age of Data indicator	1	n/a	T	2=Fresh,<10 sec. 1=Old,>10 sec. 0=Not available
Total number of characters is 65 + 4x (number of SVs used)				

***Note** – At least 2 satellites are required to get the LN Message.*

Position is in degrees, minutes, and decimal minutes. Latitude is (positive north); longitude is (positive east) WGS-84. Heading is in degrees from True North increasing eastwardly. The GPS time of day is the time of fix rounded to the nearest second.

***Note** – The data in this message is to be considered invalid and should not be used, if the Age of Data Indicator is equal to 0 (signifying data not available).*

PR Protocol

The protocol message (PR) is the method used to control which I/O protocols are active on the Lassen iQ receiver port. Each protocol can be set to:

- Off
- Input only
- Output only
- Both input and output

The PR data string format is:

[;TAIP=xy] [;TSIP=xy] [;NMEA=xy] [;RTCM=xy]

Table C.14 PR Data String Descriptions

Item	# of Char	Units	Format	Value
Port 1 protocol	1	n/a	X	T = Both in and out I = Input only O = Output only F = Off N = Not available
Port 2 protocol	1	n/a	y	T = Both in and out I = Input only O = Output only F = Off N = Not available

Sending the following message will set the receiver to TAIP-IN and TAIP-OUT on PORT 1 and RTCM-IN and NMEA-OUT on Port 2.

```
>SPR;TAIP=TF;TSIP=FF;NMEA=FO;RTCM=FI<
```

Notes – There are two restrictions to setting protocols: RTCM is input only, and NMEA is output only.

If a protocol is not implemented within the application, x and/or y will have the value N, and any set message for that protocol is ignored.

It is possible to turn off all input processing on a port. If this is done, neither TAIP nor TSIP can be used to change the active protocols.

If you do not use battery back-up and you do not have the settings saved in FLSAH memory, all port characteristics will reset to the default after power is removed.

PT Port Characteristic

This message defines the characteristics for the primary TAIP port.

Data String Format:

AAAA,B,C,D

Table C.15 Port Characteristic Data String Descriptions

Item	# of Char	Units	Format	Value
Baud Rate	4	n/a	AAAA	2400, 4800, 9600, 19200, 38400
# of data bits	1	n/a	B	(7 or 8)
# of stop bits	1	n/a	C	(1 or 2)
Parity	1	n/a	D	("N" = None) ("O" = Odd) ("E" = Even)
Total number of characters is 10 (includes commas)				

Most TAIP using receivers use the following default port characteristics

- 4800 baud
- 8 data bits
- 1 stop bit
- No parity

***Notes** – The characteristics set by this message will be stored in the receiver’s battery backed ram. The Lassen iQ receiver family of receivers do not include an internal battery but provide a battery back-up input line that may be used to retain memory when main power is removed.*

If you do not use battery back-up, all port characteristics will reset to either the default settings after power is removed, or to the settings previously stored in Flash.

The PT command uses commas between data fields.

PV Position/Velocity Solution

Note – The first character of latitude or longitude “(S)” is “+” or “-”.

Data String Format:

AAAAA(S)BBCCCC(S)DDDEEEEEFFFGGGHI

Table C.16 Position/Velocity Solution Data String Descriptions

Item	# of Char	Units	Format	Value
GPS Time of Day	5	Sec	AAAAA	
Latitude	8	Deg	(S)BBCCCC	BB=degrees CCCC=decimal degrees
Longitude	8	Deg	(S)DDDEEEEE	DDD=degrees EEEE=decimal degrees
Speed	3	MPH	FFF	
Heading	3	Deg.	GGG	
Fix Mode	1	n/a	H	0=2D GPS 1=3D GPS 2=2D DGPS 3=3D DGPS 6=Reserved 8=Reserved 9=No fix avail.
Age of Data Indicator	1	n/a	I	2=Fresh,<10 sec. 1=Old,>10 sec. 0=Not available
Total number of characters is 30				

Position is in latitude (positive north) and longitude (positive east) WGS-84. Heading is in degrees from True North increasing eastwardly. The GPS time of day is the time of fix rounded to the nearest second.

Note – The data in this message is to be considered invalid and should not be used, if the Age of Data Indicator is equal to 0 (signifying data not available).

RM Reporting Mode

Data String Format:

```
[;ID_FLAG= A][;CS_FLAG= B][;EC_FLAG= C] [;FR_FLAG= D]
[;CR_FLAG=E]
```

Table C.17 Reporting Mode Data String Descriptions

Item	# of Char	Units	Format	Value
ID Flag	1	n/a	A	T = True F = False
CS Flag	1	n/a	B	T = True F = False
EC Flag	1	n/a	C	T = True F = False
FR Flag	1	n/a	D	T = True F = False
CR Flag	1	n/a	E	T = True F = False

ID Flag determines whether the unit is to include the vehicles ID with each report.

CS Flag determines whether the unit is to include a checksum as part of each message.

EC Flag, when set, will cause the unit to echo back all complete and properly formatted set commands with a *response qualifier*. This provides an easy way to verify that the unit did in fact receive the intended data.

FR Flag indicates whether the unit is to report messages automatically per their individually scheduled frequency. When set to false, the unit will only respond when queried for a specific message.

CR Flag, when set to True, will cause the receiver to append a carriage return and line feed [CR] [LF] to the end of each message output. This is useful when viewing the unencoded receiver responses on a terminal or a PC.

The default value at start-up for ID flag and the CR flag is false; the default for CS, EC and FR flags is true.

Example

The following command will turn checksums off and carriage return on:

```
>SRM;CS_FLAG=F;CR_FLAG=T<
```

Note – Notice the use of semicolon before the flag name.

RT Reset Mode

Data String Format:

Any one of the following data strings can be set. Upper case characters are required.

[]

[COLD]

[FACTORY]

[SAVE_CONFIG]

Table C.18 Reset Mode Data String Descriptions

Message	Description
>SRT<	Warm Set
>SRTCOLD<	Cold Start
>SRFACTORY<	Factory Reset
>SRSAVE_CONFIG<	Save settings to Flash memory

The following procedure is used to change the Lassen iQ receiver protocol from TSIP to TAIP:

1. Use the TSIP 0x7E command to setup the TAIP output configuration.
2. Change the protocol to TAIP using TSIP command 0xBC.
3. Save the TAIP settings to Flash memory using the TAIP command >SRSAVE_CONFIG<.

ST Status

Data String Format:

AABCDDEFGG

***Note** – This message provides information about the satellite tracking status and the operational health of the receiver. This information is contained in five status bytes which are output as five 2 digit hexadecimal values. The data format and the meanings of the hex characters are given in the following tables.*

Table C.19 Data String HEX Characters

Item	# of Char	Units	Format	Definition
Tracking Status Code	2	n/a	AA	(see table below)
Status Codes - Nibble 1	1	n/a	B	(see table below)
Status Codes - Nibble 2	1	n/a	C	(see table below)
Machine ID	2	n/a	DD	
Status Code - Nibble 3	1	n/a	E	(not currently used)
Status Code - Nibble 4	1	n/a	F	(see table below)
Reserved	2	n/a	GG	(see table below)

Table C.20 Tracking Status Code

Value	AA Meaning
00	Doing position fixes
01	Don't have GPS time yet
02	Not used
03	PDOP is too high
08	No usable satellites
09	Only 1 usable satellite
0A	Only 2 usable satellites
0B	Only 3 usable satellites
0C	Chosen satellite is unusable

Table C.21 Error Codes: Nibble 1

Value	B Meaning
0	No problems reported
2	Antenna feedline open fault
6	Antenna feedline short fault

Table C.22 Error Codes: Nibble 2

Value	C Meaning
0	No problems reported
1	Battery-back-up failed; RAM not available at power-up (see Note below).

Table C.23 Machine ID Code

Value	DD Meaning
DD	Displays the machine ID

Table C.24 Error Codes: Nibble 3

Value	E Meaning
Not used	Not used

Table C.25 Error Codes: Nibble 4

Value	F Meaning
0	No problems reported
2	RTC not available at power-up (see Note below)
8	Stored almanac not complete and current
A	RTC not available; stored almanac not complete and current

Table C.26 Error Codes: Reserved

Value	GG Meaning
Not used	Reserved

Note – After the status is detected, this bit remains set until the receiver is reset.

TM Time/Date

Data String Format:

AABBCCDDDEEFFGGGGHHIIJKLLLLL

Table C.27 TM Time/Data String Descriptions

Item	# of Char	Units	Format	Value
Hours	2	Hour	AA	
Minutes	2	Min	BB	
Seconds	5	Sec	CC.DDD	
Date; Day	2	Day	EE	
Date; Month	2	Month	FF	
Date; Year	4	Year	GGGG	
GPS UTC Time Offset	2	Sec	HH	
Fix Mode	1	n/a	f	0=2D GPS 1=3D GPS 2=2D DGPS 3=3D DGPS 6=Reserved 8=Reserved 9=No fix avail.
Number of usable satellites	2	n/a	JJ	
GPS UTC Offset flag	1	n/a	K	(1 = Valid) (0 = Invalid)
Reserved	5	n/a	LLLLL	
Total number of characters is 28				

This message outputs the time and date as computed by the GPS receiver. The time is most accurate when the unit is doing fixes. It is less accurate but still usable when the unit is not doing fixes but the Number of Usable SVs is one or more. If the GPS UTC offset is available, the time will be in UTC. If not, the time will be in GPS.

Note 1. – GPS UTC Time Offset is the difference between GPS and UTC time standards in seconds. The UTC time of Day is only valid if the GPS UTC Offset Valid Flag is indicating valid.

Note 2.– The TM message is not supported under the Set qualifier.

VR Version Number

Data String Format:

XXXXXXXX;VERSION A.AA(BB/BB/BB); CORE VERSION C.CC
(DD/DD/DD); E

Table C.28 Version Number Data String Descriptions

Item	# of Char	Units	Format
Product Name	n/a	n/a	n/a
Major version number	4	n/a	A.AA
Major release date	8	n/a	BB/BB/BB

X1 Extended Status

The Lassen iQ receiver does not support this message.

Communication Scheme for TAIP

Communication with the unit takes place in four different ways. Message qualifiers are used to differentiate between these.

Query for Single Sentence

The query (Q) message qualifier is used to query the GPS receiver to respond immediately with a specific message. The format is:

```
>QAA[;ID=BBBB][;*CC]<
```

where AA is the requested message identifier. Messages supported by this qualifier are

AL, AP, CP, ID, IP, LN, PT, PV, RM, ST, TM, and VR.

Scheduled Reporting Frequency Interval

The scheduled reporting frequency interval (F) message qualifier is used to tell the unit how often and when to report a specific message. The format is:

```
>FAABBBBCCCC[;ID=DDDD][;*FF]<
```

where sending this sentence tells the unit to report message specified by the two digit identifier AA at the time interval of BBBB seconds with time epoch at CCCC seconds from top of the hour. Specifying time interval of 0000 stops scheduled reporting of the message. The default is 0000 time interval for all messages except PV. The output frequency for PV at cold-start is set at once every five seconds, zero seconds from top of the hour. Messages supported by this qualifier are AL, AP, CP, ID, IP, LN, PT, PV, RM, ST, TM, and VR.

Notes – The Lassen iQ GPS receiver firmware version 1.10 does not support the AP TAIP message.

The data specified by this qualifier is the timing of the message output and may be different from the time tag of the data in the message.

The Response to Query or Scheduled Report

The response (R) qualifier carry various types of data between the unit and the user equipment. The format is:

```
>RAA[{B}][;ID=CCCC][;*DD]<
```

where AA is the two character message identifier and {B} specifies the data string within the message. For the format of {B}, please refer to the message definitions in the previous section. Messages supported by the response qualifier are AL, AP, CP, ID, IP, LN, PT, PV, RM, ST, TM, and VR.

Note – The Lassen iQ GPS receiver firmware version 1.10 does not support the AP TAIP message.

The Set Qualifier

The set (S) qualifier enables the user equipment to initialize/set-up various types of data in the GPS unit. The format is:

```
>SAA[{B}][;ID=CCCC][;*DD]<
```

where AA is the two character message identifier and {B} specifies the data string within the message. For the format of {B}, please refer to the message definitions in the previous section. Note that all the messages have very specific formats and are length dependent.

Messages normally supported by the set qualifier are AL, AP, CP, DC, DD, ID, IP, LN, PT, PV, and RM.

The set qualifier may be used with the AL, CP, LN, or PV message to set more precise initial position data into the GPS receiver than can be set with the IP message.

Note – The Lassen iQ GPS receiver firmware version 1.10 does not support the AP TAIP message.

Sample Communication Session

The following is a sample communication session to illustrate how message qualifiers are used. Query the receiver for version number for the TAIP firmware:

```
>QVR<
```

The receiver responds with a message in the following form:

```
>RVR OEM SQ OEM STTP APP; VERSION 1.04 (05/23/02);*38<
```

***Note** – The receiver identified its product name, firmware version number, core signal processing version number, and release dates, then included the checksum for the message (the default for the CS Flag is TRUE). Also notice that the receiver did respond to our query even though we did not send a checksum.*

Query the receiver for its ID number:

```
>QID<
```

The receiver will respond (assuming factory default settings):

```
>RID0000;*70<
```

Set the ID to match the number for a vehicle in your fleet and then tell the receiver to include the Vehicle ID in its responses:

```
>SID1234<
```

```
>SRM;ID_FLAG=T<
```

The Lassen iQ receiver receiver is set by default to report the PV message once every 5 seconds. To schedule the PV message from vehicle 1234 to respond once every 10 seconds, starting at 5 seconds after the top of the hour, use the following command:

```
>FPV00100005;ID=1234<
```

The receiver will check the ID included in the message for a match with its own and then reschedule the PV message. At the next scheduled time, the receiver will respond with:

```
>RPV15714+3739438-1220384601512612;ID=1234;*7F<
```

***Note** – The Lassen iQ GPS receiver firmware version 1.10 does not support the AP TAIP message.*

The time given in the message is the time of the last GPS fix (04:21:54 GPS), not necessarily the time of the message response. If the time of last fix is 10 or more seconds old, the age flag will be set to 1.

GPSSK User's Guide (TAIP)

The TAIP Tool Kit, known as GPSSK is a software package available from Trimble Navigation to assist users of the Trimble ASCII Interface Protocol (TAIP). GPSSK supports all Trimble receivers that use TAIP.

GPSSK can be used to setup, diagnose, and monitor your sensor and provides the following capabilities:

- Program the GPS sensor for automatic message reporting and verify the success of the programming.
- Quickly program Vehicle ID numbers into a fleet of sensors.
- Log the GPSSK session with the GPS sensor to disk and replay the data.
- On-screen plotting of GPS positions from the sensor.
- Poll for and view combinations of TAIP messages.
- Set different polling intervals for each message type.
- Conduct an interactive terminal session with the GPS sensor.

***Note** – The information about GPSSK in this document is presented as a general overview. The GPSSK distribution diskette includes a READ.ME file that details the most current information about GPSSK functions and on loading and using GPSSK.*

The GPSSK program does not support the TAIP messages DC and DD. These messages are used to input differential corrections to the receiver and are defined as special TAIP format versions of RTCM SC-104 Type 1 and Type 2 messages.

The GPSSK program requires well over 500K RAM. It may not run in a DOS window, and may require removal of TSRs.

The GPSSK Files

GPSSK is included on the CD in the Lassen iQ GPS receiver Starter Kit. The CD contains the following GPSSK related files:

- GPSSK.EXE The executable GPSSK program.
- GPSSK.HLP The on-line, context-sensitive help file.
- READ.ME Current information about GPSSK.
- TAIP.C Sample source code for encoding and decoding TAIP.

TAIP.C Source File

The sample source code for encoding and decoding TAIP messages is provided as a guide for the system integrator who is developing a communications controller that handles TAIP. There is no warranty of any kind on this software. Use it at your own risk.

The distribution diskette is not copy protected. Before using GPSSK or installing on your hard disk, make a working copy and put the original diskette in a safe place. During normal use, GPSSK will save configuration information to the diskette or current directory. Storing the original diskette away will allow you to restore the original configuration should you encounter problems.

Copy the files GPSSK.EXE and GPSSK.HLP to a hard disk directory.

GPSSK Start-up

At the DOS prompt in the directory containing GPSSK, enter the command:

GPSSK

When the program is finished loading into memory, the GPSSK title page will be displayed. The program will then wait for 10 seconds to begin normal execution; you may bypass the 10 second wait by pressing any key after the title page is displayed.

The function key menu will be displayed on the bottom of the screen. GPSSK is structured as a hierarchy of menus. The function keys control access to the menus.

To terminate GPSSK, simply back out of the menu structure by pressing [F9] until GPSSK prompts you to confirm your desire to exit the program.

At start-up, GPSSK will attempt to initialize itself by querying the sensor for some basic information. If you wish to abort the sensor initialization process and use GPSSK to replay stored data, enter [Ctrl] + [X] (hold down the control key and press x). If initialization has been aborted, you must restart GPSSK when you wish to communicate with the sensor.

On-line Help

Once GPSSK is running, on-line help is available to assist in performing all the GPSSK operations. Help is context sensitive and will display information regarding the current display or menu. A brief overview of GPSSK is available in the main menu's help screen.

There are several command line options available. For help with command line options, run GPSSK with the /HELP argument:

GPSSK /HELP

The help available on the GPSSK main menu will explain menu operation and the menu hierarchy.

Connecting the GPS Sensor

Consult the *Installation and Operator's Manual* for information on installation, power requirements and cables specific to your Lassen SK II GPS sensor.

Connect the serial port of the sensor to the computer's COM1 or COM2 port. The default serial port settings for GPSSK are:

- 4800 baud
- 8 data bits
- 1 stop bit
- no parity

These default settings match the default settings for the Lassen SK II GPS sensor. Consult the *Installation and Operator's Manual* for the actual default settings and type of serial port on your sensor.

If the sensor is connected to COM2, start GPSSK by entering the command:

GPSSK /2

Note – A null modem may be required when connecting the sensor to a personal computer. The serial port on your computer is a DTE port (data terminal equipment) designed to connect to a DCE port (data communications equipment). If your sensor's serial port is DTE, you must use a null modem adapter.

NMEA 0183

This appendix provides a brief overview of the NMEA 0183 protocol, and describes both the standard and optional messages offered by the Lassen iQ GPS receiver.

NMEA 0183 is a simple, yet comprehensive ASCII protocol which defines both the communication interface and the data format. The NMEA 0183 protocol was originally established to allow marine navigation equipment to share information. Since it is a well established industry standard, NMEA 0183 has also gained popularity for use in applications other than marine electronics. The Lassen iQ receiver supports the latest release of NMEA 0183, Version 3.0 (July 1, 2000). The primary change in release 3.0 is the addition of the mode indicators in the GLL, RMC, and VTG messages.

For those applications requiring output only from the GPS receiver, NMEA 0183 is a popular choice since, in many cases, an NMEA 0183 software application code already exists. The Lassen iQ GPS receiver is available with firmware that supports a subset of the NMEA 0183 messages: GGA, GLL, GSA, GSV, RMC, VTC, and ZDA.

For a complete copy of the NMEA 0183 standard, contact:

NMEA National Office
PO Box 3435
New Bern, NC 28564-3435
U.S.A.
Telephone: +1-919-638-2626
Fax: +1-919-638-4885

The NMEA 0183 Communication Interface

NMEA 0183 allows a single source (talker) to transmit serial data over a single twisted wire pair to one or more receivers (listeners). The table below lists the standard characteristics of the NMEA 0183 data transmissions.

Table E.1 NMEA 0183 Standard Characteristics

Signal Characteristic	NMEA Standard
Baud Rate	4800
Data Bits	8
Parity	None (Disabled)
Stop Bits	1

NMEA 0183 Message Format

The NMEA 0183 protocol covers a broad array of navigation data. This broad array of information is separated into discrete messages which convey a specific set of information. The entire protocol encompasses over 50 messages, but only a sub-set of these messages apply to a GPS receiver like the Lassen iQ GPS receiver. The NMEA message structure is described below.

`$IDMSG,D1,D2,D3,D4, ,Dn*CS[CR][LF]`

“\$”	The “\$” signifies the start of a message.
ID	The talker identification is a two letter mnemonic which describes the source of the navigation information. The GP identification signifies a GPS source.
MSG	The message identification is a three letter mnemonic which describes the message content and the number and order of the data fields.
“,”	Commas serve as delimiters for the data fields.
Dn	Each message contains multiple data fields (Dn) which are delimited by commas.
“*”	The asterisk serves as a checksum delimiter.
CS	The checksum field contains two ASCII characters which indicate the hexadecimal value of the checksum.
[CR][LF]	The carriage return [CR] and line feed [LF] combination terminate the message.

NMEA 0183 messages vary in length, but each message is limited to 79 characters or less. This length limitation excludes the “\$” and the [CR][LF]. The data field block, including delimiters, is limited to 74 characters or less.

Field Definitions

Many of the NMEA date fields are of variable length, and the user should always use the comma delineators to parse the NMEA message date field. Table E.2 specifies the definitions of all field types in the NMEA messages supported by Trimble.

Table E.2 Field Type Summary

Type	Symbol	Definition
Status	A	Single character field: A=Yes, data valid, warning flag clear V=No, data invalid, warning flag set
Special Format Fields		
Latitude	lll.lll	Fixed/variable length field: Degreesminutes.decimal-2 fixed digits of degrees, 2 fixed digits of minutes and a variable number of digits for decimal-fraction of minutes. Leading zeros always included for degrees and minutes to maintain fixed length. The decimal point and associated decimal-fraction are optional if full resolution is not required.
Longitude	yyyyy.yyy	Fixed/Variable length field: Degreesminutes.decimal-3 fixed digits of degrees, 2 fixed digits of minutes and a variable number of digits for decimal-fraction of minutes. Leading zeros always included for degrees and minutes to maintain fixed length. The decimal point and associated decimal-fraction are optional if full resolution is not required.
Time	hhmmss.ss	Fixed/Variable length field: hoursminutesseconds.decimal-2 fixed digits of minutes, 2 fixed digits of seconds and a variable number of digits for decimal-fraction of seconds. Leading zeros always included for hours, minutes, and seconds to maintain fixed length. The decimal point and associated decimal-fraction are optional if full resolution is not required.

Table E.2 Field Type Summary (Continued)

Type	Symbol	Definition
Defined		Some fields are specified to contain pre-defined constants, most often alpha characters. Such a field is indicated in this standard by the presence of one or more valid characters. Excluded from the list of allowable characters are the following that are used to indicated field types within this standard: “A”, “a”, “c”, “hh”, “hhmmss.ss”, “llll.ll”, “x”, “yyyy.yy”
Numeric Value Fields		
Variable	x.x	Variable length integer or floating numeric field. Optional leading and trailing zeros. The decimal point and associated decimal-fraction are optional if full resolution is not required (example: 73.10=73.1=073.1=73).
Fixed HEX	hh	Fixed length HEX numbers only, MSB on the left
Information Fields		
Fixed Alpha	aa	Fixed length field of upper-case or lower-case alpha characters
Fixed number	xx	Fixed length field of numeric characters

Note – Spaces are only be used in variable text fields.

Note 2 – Units of measure fields are appropriate characters from the Symbol column (see Table E.2), unless a specified unit of measure is indicated.

Note 3 – Fixed length field definitions show the actual number of characters. For example, a field defined to have a fixed length of 5 HEX characters is represented as hhhhh between delimiters in a sentence definition.

NMEA 0183 Message Options

The Lassen iQ GPS receiver can output any or all of the messages listed in Table E.3. In its default configuration (as shipped from the factory), the Lassen iQ GPS receiver outputs two messages: GGA and VTG. These messages are output at a 1 second interval with the “GP” talker ID and checksums. These messages are output at all times during operation, with or without a fix. If a different set of messages has been selected (using Packet 0x7A), and this setting has been stored in Flash memory (using Packet 0x8E-26), the default messages are permanently replaced until the receiver is returned to the factory default settings.

Note – The user can configure a custom mix of the messages listed in Table E.3. See Chapter 3, and TSIP command packets 0xBC, 0x7A, and 8E-26 in Appendix A for details on configuring NMEA output.

Warning – If too many messages are specified for output, you may need to increase the unit’s baud rate.

Table E.3 Lassen SQ GPS Receiver NMEA Messages

	Message	Description
Default Output	GGA	GPS fix data
	GLL	Geographic position - Latitude/Longitude
	GSA	GPS DOP and active satellites
	GSV	GPS satellites in view
	RMC	Recommended minimum specific GPS/Transit data
Default Output	VTG	Track made good and ground speed
	ZDA	Time & Date

The format for each message in Table E.3 is described in more detail in the next section.

NMEA 0183 Message Formats

GGA - GPS Fix Data

The GGA message includes time, position and fix related data for the GPS receiver.

```
$GPGGA,hhmmss.ss,llll.lll,a,nnnnn.nnn,b,t,uu,
v.v,w.w,M,x.x,M,y.y,zzzz*hh <CR><LF>
```

Table E.4 GGA - GPS Fix Data Message Parameters

Field #	Description
1	UTC of Position (when UTC offset has been decoded by the receiver)
2,3	Latitude, N (North) or S (South)
4,5	Longitude, E (East) or W (West)
6	GPS Quality Indicator: 0 = No GPS, 1 = GPS, 2 = DGPS
7	Number of Satellites in Use
8	Horizontal Dilution of Precision (HDOP)
9, 10	Antenna Altitude in Meters, M = Meters
11, 12	Geoidal Separation in Meters, M=Meters. Geoidal separation is the difference between the WGS-84 earth ellipsoid and mean-sea-level.
13	Age of Differential GPS Data. Time in seconds since the last Type 1 or 9 Update
14	Differential Reference Station ID (0000 to 1023)
hh	Checksum

GLL - Geographic Position - Latitude/Longitude

The GLL message contains the latitude and longitude of the present vessel position, the time of the position fix and the status.

```
$GPGLL,1111.111,a,YYYYY.YYY,a,hhmmss.ss,A,i*hh<CR>
<LF>
```

Table E.5 GLL - Geographic Position - Latitude / Longitude Message Parameters

Field #	Description
1,2	Latitude, N (North) or S (South)
3,4	Longitude, E (East) or W (West)
5	UTC of position (when UTC offset has been decoded by the receiver)
6	Status: A = Valid, V= Invalid
7	Mode Indicator A=Autonomous Mode D=Differential Mode E=Estimated (dead reckoning) Mode M=Manual Input Mode S=Simulated Mode N-Data Not Valid
hh	Checksum

GSA - GPS DOP and Active Satellites

The GSA messages indicates the GPS receiver's operating mode and lists the satellites used for navigation and the DOP values of the position solution.

```
$GPGSA, a, x, xx, xx, xx, xx, xx, xx, xx, xx, xx, xx, xx, xx,
xx, x.x, x.x, x.x*hh<CR><LF>
```

Table E.6 GSA - GPS DOP and Active Satellites Message Parameters

Field #	Description
1	Mode: M = Manual, A = Automatic. In manual mode, the receiver is forced to operate in either 2D or 3D mode. In automatic mode, the receiver is allowed to switch between 2D and 3D modes subject to the PDOP and satellite masks.
2	Current Mode: 1 = fix not available, 2 = 2D, 3 = 3D
3 to 14	PRN numbers of the satellites used in the position solution. When less than 12 satellites are used, the unused fields are null
15	Position dilution of precision (PDOP)
16	Horizontal dilution of precision (HDOP)
17	Vertical dilution of precision (VDOP)
hh	Checksum

GSV - GPS Satellites in View

The GSV message identifies the GPS satellites in view, including their PRN number, elevation, azimuth and SNR value. Each message contains data for four satellites. Second and third messages are sent when more than 4 satellites are in view. Fields #1 and #2 indicate the total number of messages being sent and the number of each message respectively.

```
$GPGSV,x,x,xx,xx,xxx,xx,xx,xx,xxx,xx,xx,xx,xxx,xx,xx,xx,xx,xxx,xx,xx,xxx,xx*hh<CR><LF>
```

Table E.7 GSV - GPS Satellites in View Message Parameters

Field #	Description
1	Total number of GSV messages
2	Message number: 1 to 3
3	Total number of satellites in view
4	Satellite PRN number
5	Satellite elevation in degrees (90° Maximum)
6	Satellite azimuth in degrees true (000 to 359)
7	Satellite SNR (C/No), null when not tracking
8,9,10,11	PRN, elevation, azimuth and SNR for second satellite
12,13,14,15	PRN, elevation, azimuth and SNR for third satellite
16,17,18,19	PRN, elevation, azimuth and SNR for fourth satellite
hh	Checksum

RMC - Recommended Minimum Specific GPS/Transit Data

The RMC message contains the time, date, position, course, and speed data provided by the GPS navigation receiver. A checksum is mandatory for this message and the transmission interval may not exceed 2 seconds. All data fields must be provided unless the data is temporarily unavailable. Null fields may be used when data is temporarily unavailable.

```
$GPRMC, hhmmss.ss,A, llll.ll, a, YYYYY.YY, a,
x.x, x.x, xxxxxx, x.x, a, i*hh<CR><LF>
```

Table E.8 RMC - Recommended Minimum Specific GPS / Transit Data Message Parameters

Field #	Description
1	UTC of Position Fix (when UTC offset has been decoded by the receiver).
2	Status: A = Valid, V = navigation receiver warning
3,4	Latitude, N (North) or S (South).
5,6	Longitude, E (East) or W (West).
7	Speed over the ground (SOG) in knots
8	Track made good in degrees true.
9	Date: dd/mm/yy
10,11	Magnetic variation in degrees, E = East / W= West
12	Position System Mode Indicator; A=Autonomous, D=Differential, E=Estimated (Dead Reckoning), M=Manual Input, S=Simulation Mode, N=Data Not Valid
hh	Checksum (Mandatory for RMC)

VTG - Track Made Good and Ground Speed

The VTG message conveys the actual track made good (COG) and the speed relative to the ground (SOG).

\$GPVTG,x.x,T,x.x,M,x.x,N,x.x,K,i*hh<CR><LF>

Table E.9 VTG - Track Made Good and Ground Speed Message Parameters

Field #	Description
1	Track made good in degrees true.
2	Track made good in degrees magnetic.
3,4	Speed over the ground (SOG) in knots.
5,6	Speed over the ground (SOG) in kilometer per hour.
7	Mode Indicator: A=Autonomous Mode, D=Differential Mode, E=Estimated (dead reckoning) Mode, M=Manual Input Mode, S=Simulated Mode, N-Data Not Valid
hh	Checksum

ZDA - Time & Date

The ZDA message contains UTC, the day, the month, the year and the local time zone.

```
$GPZDA, hhmmss.ss, xx, xx, xxxx, , *hh<CR><LF>
```

Table E.10 ZDA - Time & Date Message Parameters

Field #	Description
1	UTC (when UTC offset has been decoded by the receiver)
2	Day (01 to 31)
3	Month (01 to 12)
4	Year
5	unused
6	unused
hh	Checksum

Note – Fields #5 and #6 are null fields in the Lassen iQ GPS receiver output. A GPS receiver cannot independently identify the local time zone offsets.

Warning – If UTC offset is not available, time output will be in GPS time until the UTC offset value is collected from the GPS satellites. When the offset becomes available, the time will jump to UTC time.

Note – The time can be used as a timetag for the 1PPS. The ZDA message comes out 100-500 msec after the PPS.

Exception Behavior

When no position fix is available, some of the data fields in the NMEA messages will be blank. A blank field has no characters between the commas. There are three general cases when no fix is available: at power-up without BBRAM (cold start); at power-up with BBRAM (warm start); and when the GPS signal is temporarily blocked. These three cases have different NMEA output behavior in the Lassen iQ GPS receiver. This section describes the behavior for the current product. The specification for this behavior may change in future products.

Power-up with No BBRAM

In this case, no previous fix is available in battery-backed memory. If the output message list and output rate has been customized (using TSIP command packet 0x7A) and stored in Flash memory, then at power-up the receiver will output the messages according to the customized setting. Otherwise, GGA and VTG messages are output every second. Before fixes are available, the message fields will be empty.

Power-up with BBRAM

In this case, a previous fix is available in battery-backed memory at power-up. If the output message list and output rate has been customized (using TSIP command packet 0x7A) and stored in Flash memory, then at power-up the receiver will output the messages according to the customized setting. Otherwise, GGA and VTG messages are output every second. Before fixes are available, the message fields will be empty except for the Time field, assuming the back-up battery power is present so that time can be tracked continuously by the RTC (Real Time Clock).

Interruption of GPS Signal

If the GPS signal is interrupted temporarily, the NMEA will continue to be output according to the user-specified message list and output rate. Position and velocity fields will be blank until the next fix, but most other fields will be filled.

Specifications and Mechanical Drawings

The Lassen iQ GPS receiver is designed for embedded industrial computing or control, mobile computing or data collection, precision timing, and vehicle tracking applications. This appendix includes the system specifications and mechanical drawings for the Lassen SQ GPS receiver module and the available GPS antennas.

Lassen iQ GPS Receiver Specifications

Key Features

12-channel simultaneous operation
Ultra-low power consumption, less than 89 mW (27 mA) @ 3.3 V
Dual sensitivity modes with automatic switching
Aided GPS through TSIP
Antenna open and short circuit detection and protection
Compact size: 26 mm W x 26 mm L x 6 mm H
Supports NMEA 0183, TSIP, and TAIP protocols
DGPS capable
Trimble quality at low cost

Performance

General	L1 frequency (1575.42 MHz), C/A code (Standard Positioning Service), 12-channel, continuous tracking receiver
Update Rate	TSIP @ 1 Hz; NMEA @ 1 Hz; TAIP @ 1Hz
Accuracy	Horizontal: <5 meters (50%), <8 meters (90%) Altitude: <10 meters (50%), <16 meters (90%) Velocity: 0.06 m/sec. PPS (static): ± 50 nanoseconds
Acquisition	(Autonomous Operation in Standard Sensitivity Mode) Reacquisition: <2 sec. (90%) Hot Start: <10 sec. (50%), <13 sec. (90%) Warm Start: <38 sec. (50%), <42 sec. (90%)

Cold Start: <50 sec. (50%), <84 sec. (90%)
 (Cold Start requires no initialization, Warm Start implies last position, time and almanac are saved by backup power. Hot start implies ephemeris also saved.

Optional (COCOM) Limits

Altitude: 18,000 m

Velocity: 515 m/s

Either limit may be exceeded, but not both.

Interface

Connectors	I/O: 8-pin (2x4) 2 mm male header, micro terminal strip ASP 69553.01 RF: Low-profile coaxial connector H.FL-R-SMT (10), 50 Ohm
Serial Port	2 serial ports (transmit/receive)
PPS	3.3 V CMOS-compatible, TTL-level pulse Once per second
Protocols	TSIP, TAIP, NMEA 0183 v3.0, RTCM SC-104
NMEA	GGA, VTG, GLL, ZDA, GSA, GSV and RMC Messages selectable by TSIP command; selection stored in flash memory.

Electrical

Prime Power	+3.0 VDC to +3.6 VDC (3.3 V typ.)
Consumption	Less than 89 mW (27 mA) @ 3.3 V
Backup Power	+2.5 VDC to +3.6 VDC (3.0V typ.)
Ripple Noise	Max 60 mV, peak-to-peak from 1 Hz to 1 MHz
Antenna Fault Protection	Open and short circuit detection and protection.

Environmental

Operating Temp.	-40°C to +85°C
Storage Temp.	-55°C to +105°C
Vibration	0.008 g ² /Hz, 5 Hz to 20 Hz 0.05 g ² /Hz, 20 Hz to 100 Hz -3dB/OCTAVE, 100 Hz to 900 Hz
Humidity	5% to 95% R.H. non-condensing @ +60°C

Physical

Enclosure	Metal enclosure with solder mounting tabs
Outside Dim.	26 mm W x 26 mm L x 6 mm H (1.02" x 1.02" x 0.24")
Weight	Approximately 6.5 grams (0.2 ounces) including the shield

Accessories

Module	Lassen iQ module, in metal enclosure with solder mounting tabs.
Starter Kit	Includes Lassen iQ module mounted on interface motherboard in a durable metal enclosure, AC/DC power converter, compact magnetic-mount GPS antenna, ultra-compact embedded antenna, serial interface cable, cigarette lighter adapter, software toolkit and manual on CD-ROM.
Antenna Transition Cable, MCX	RF cable for connecting antennas with MCX connector to on-module H.FL-RF connector. Cable length is 10 cm.

Antenna Transition Cable, SMA

RF cable for connecting antennas with SMA connector to on-module H.FL-RF connector. Cable length is 12.9 cm.

Ultra-Compact Embedded Antenna

3.3V active miniature unpackaged antenna. Cable length: 8cm, Dim: 22 mm W x 21 mm L x 8 mm H (0.866" x 0.827" x 0.315"), Connector: HFL; mates directly to on-module RF connector.

Compact Unpackaged Antenna

3 V active micropatch unpackaged antenna. Cable length: 11cm, Dim: 34.6 mm W x 29 mm L x 9 mm H (1.362" x 1.141" x 0.354"), Connector: MCX; mates with optional RF transition cable to the on-module RF connector.

Compact Magnetic-Mount Antenna, MCX or SMA

3 V active micropatch antenna with magnetic mount. Cable length: 5m, Dim: 42mm W x 50.5mm L x 13.8mm H (1.65" x 1.99" x 0.55"), Connectors: MCX or SMA; mates through the optional RF transition cable to the on-module RF connector.

Lassen IQ GPS Receiver

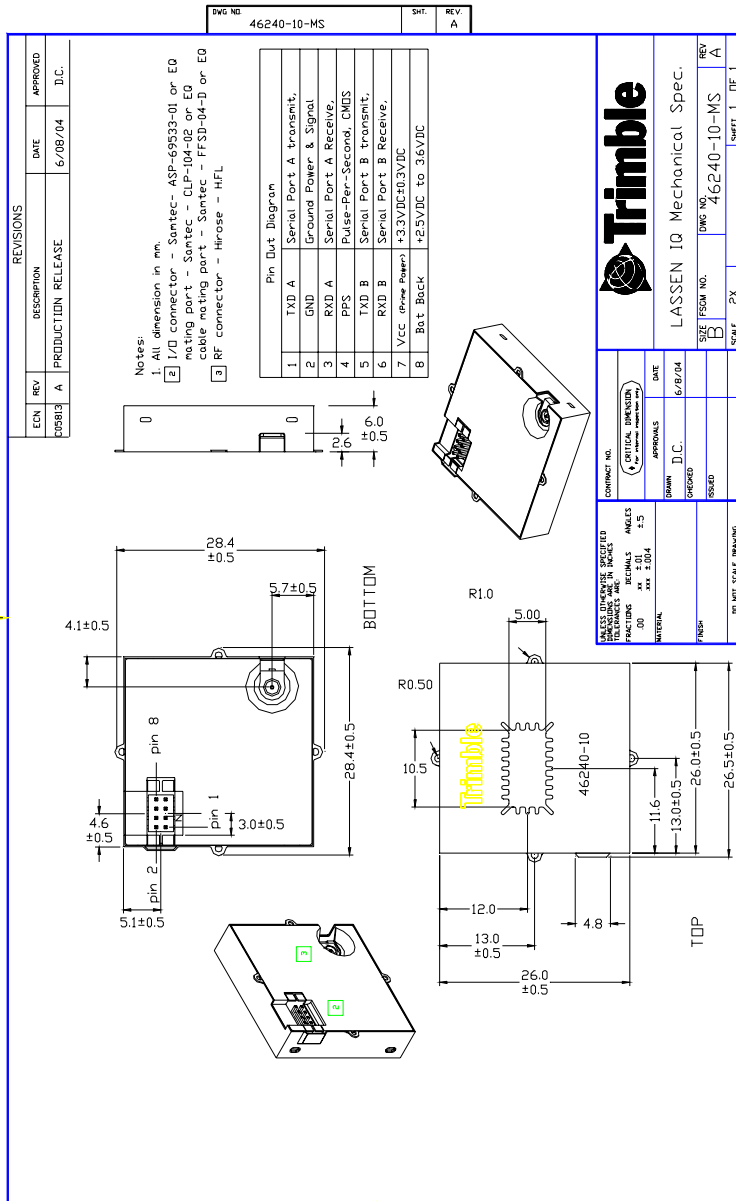

Ultra Compact Embedded Antenna

Antenna

Frequency Range	1,575.42 ± 1.023MHz
Gain	90°: 3.0dBi min.; 20°: -4.0dBi min (mounted on the 60mm X 60mm square ground plane)
Polarization	RHCP
Axial Ratio	90°: 4.0dB max.; 10°: 6.0dB max. (mounted on the 60mm X 60mm square ground plane)

LNA

Frequency range	1,575.42 ± 1.023MHz
Gain	24 3 dB (+25°C ± 5°C) 24 ± 4 dB (-40°C to 85°C)
Noise	1.5dB max. (+25°C ± 5°C) 2.0dB max. (+85°C)

Out of band rejection

f_o	1,575.42MHz
$f_o \pm 20$ MHz	7dB min.
$f_o \pm 30$ MHz	12dB min.
$f_o \pm 50$ MHz	20dB min.
$f_o \pm 100$ MHz	30dB min.

Output Impedance 50Ω

Output VSWR 2.0MAX.

Overall Specifications

Frequency Range	1,575.42±1.023MHz
Gain	27 ± 3dBi (+25°C ± 5°C) 27 ± 4dBi (-40°C TO 85°C) (mounted on the 60mm x 60mm square ground plane)
Output Impedance	50Ω
VSWR	2.0 max.
MTBF	5.13E+6Hr.

Storage Conditions

Store in room condition as listed below.

Temperature	-20°C to 45°C, humidity 80% max.
Data	Gain (at 3.0V ± 0.3V f=1575MHz) and power consumption at room temperature

General

Operating Temp.	-40°C to + 85°C
Storage Temp.	-40°C to + 100°C
Relative Humidity	20% to 95%
Input voltage	3.0V ± 0.3V
Power Cons.	5-13mA
Output connect.	HFL
Cable	0.8D 85mm: BLACK
Weight	20g TYP

Compact Magnetic Mount Antenna

Antenna

Frequency Range	1,575.42+/-1.023MHz
Gain	90°: 3.0dBi min.; 20°: -4.0dBi min. (mounted on the 65mm X 65mm square ground plane)
Polarization	RHCP
Axial Ratio	90°: 4.0dB max.; 10°: 6.0dB max. (mounted on the 65mm X 65mm square ground plane)

LNA

Frequency range	1,575.42 ±1.023MHz
Gain	28 ±3 dB (-40°C to 85°C)
Noise	1.5dB max. (+25°C ± 5°C) 2.2dB max. (+85°C)

Out of band rejection

$f_o=1,575.42\text{MHz}$	
$f_o\pm 20\text{MHz}$	7dB min.
$f_o\pm 30\text{MHz}$	12dB min.
$f_o\pm 50\text{MHz}$	20dB min.
$f_o\pm 100\text{MHz}$	30dB min.

Output Impedance 50Ω

Output VSWR 2.0max.

Overall Specifications

Frequency Range	1,575.42 ± 1.023MHz
Gain	27 ± 3dBi (+25°C ± 5°C) 27 ± 4dBi (-40°C to 85°C) (mounted on the 65mm x 65mm square ground plane)
Output Impedance	50Ω
VSWR	2.0MAX.
ESD	Antenna surface ± 15KV Connector pin ± 8KV
MTBF	5.13E+6Hr.

Storage Conditions

Temperature	-20°C to 45°C, humidity 80% max. consumption at room temperature
-------------	---

General

Operating Temp.	-40°C to + 85°C
Storage Temp.	-40°C to + 100°C
Relative Humidity	20% to 95%
Input voltage	3.0V ± 0.3V
Power Cons.	15mA max (room temp)
Output connect.	MCX (plug)
Cable	1.5DS-QEHV (Shikoku Cable Co.) black: 5m
Weight	20g TYP

Mechanical

Mounting	Magnetic mount
Force of magnet	3.0kgf min.
Water proof	JISD0203 S2)
Shock	50G vertical axis 30G all axis
Vibration	10~200Hz log sweep 3.0G (sweep time: 15 min.) 3 axis
Withstand	min. speed of 180Km/h
Cable pulling force	5kgf min. Visible or electrical damage must not appear when applying up to 5kgf pulling force between cable and antenna as well as between cable and connector.
Bending test	After bending test 90° right and left x 1000 cycles, no permanent damage found
Anti-corrosion	Based on JIS Z 2371, spray 5%; salt water 35°C; should not rust after 96 hours
Weight	115g ± 15g

Compact Magnetic Mount antenna with 5 m Cable and MCX Connector

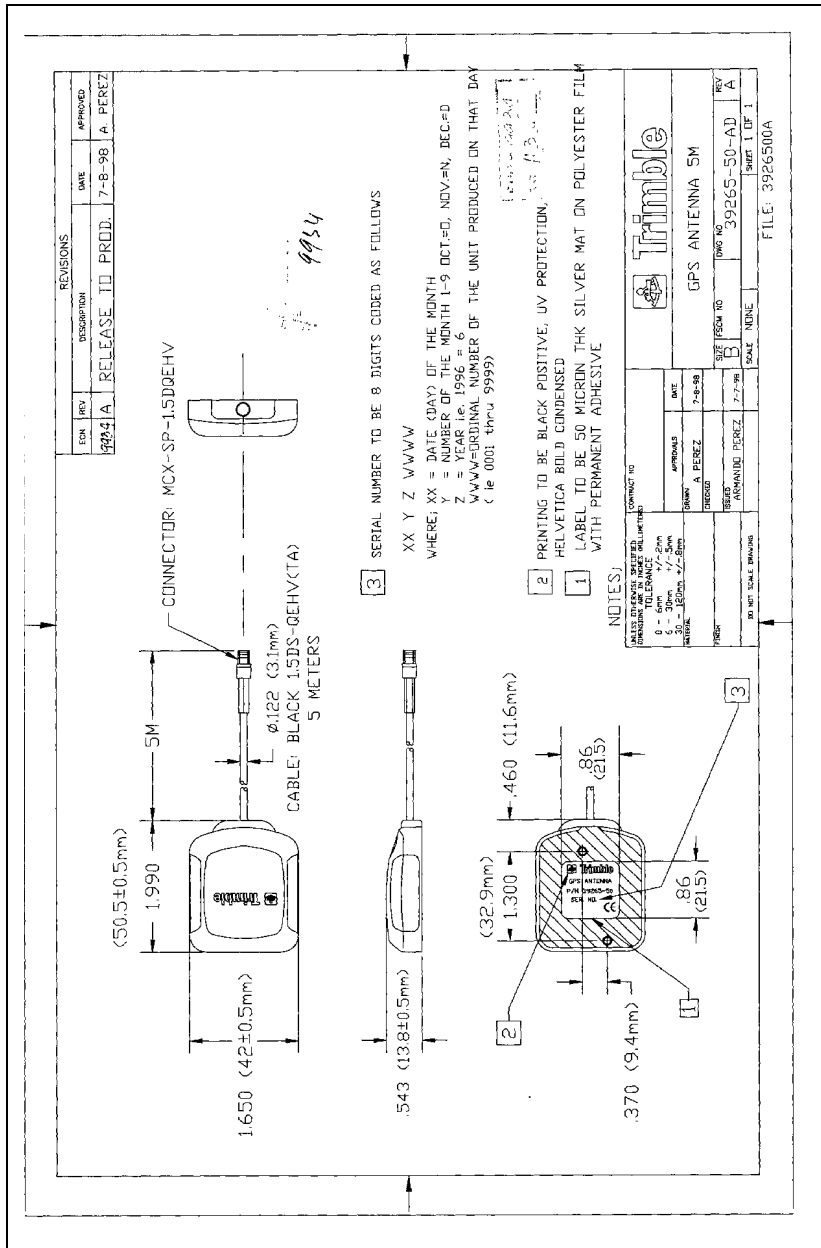

Compact Magnetic Mount antenna with 5 m Cable and SMA Connector

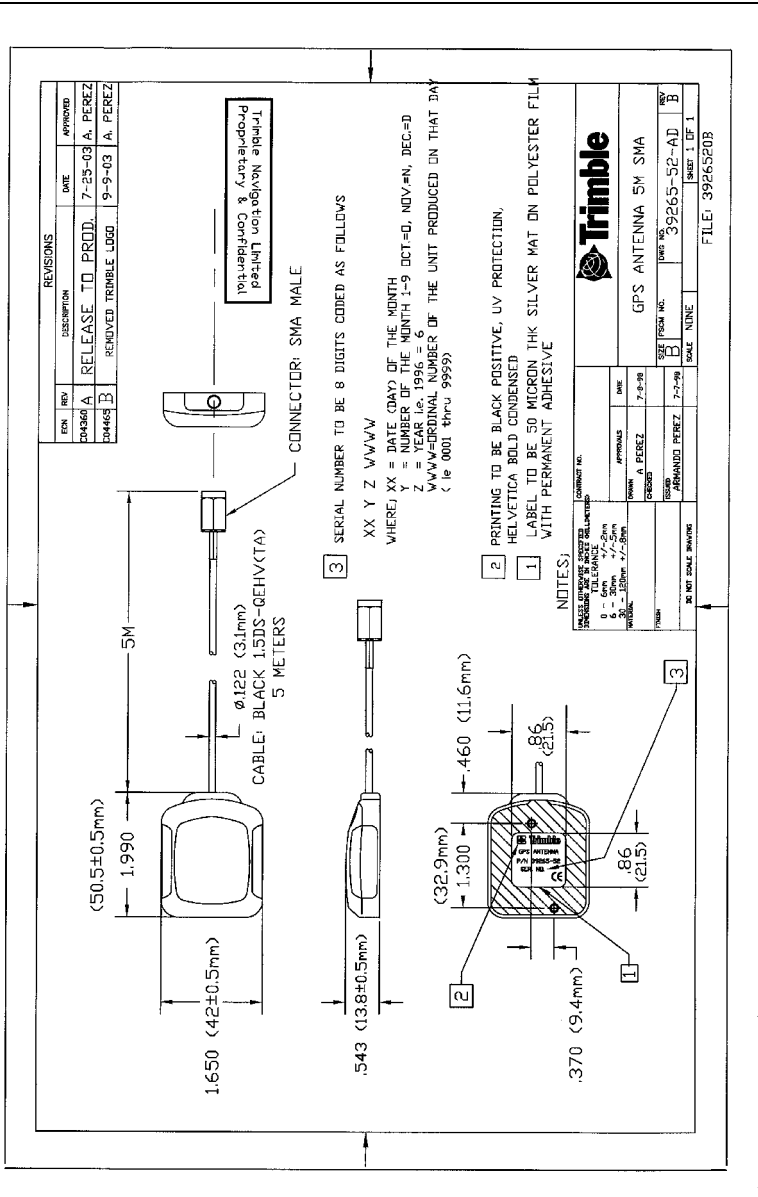

Compact Unpackaged Antenna

The specifications for this antenna are identical to that of the Compact Magnetic Mount Antenna described earlier in this Appendix, with two exceptions:

- The cable length is 11 cm.
- The connector is a right angle MCX.

Compact Unpackaged Antenna with MCX Connector

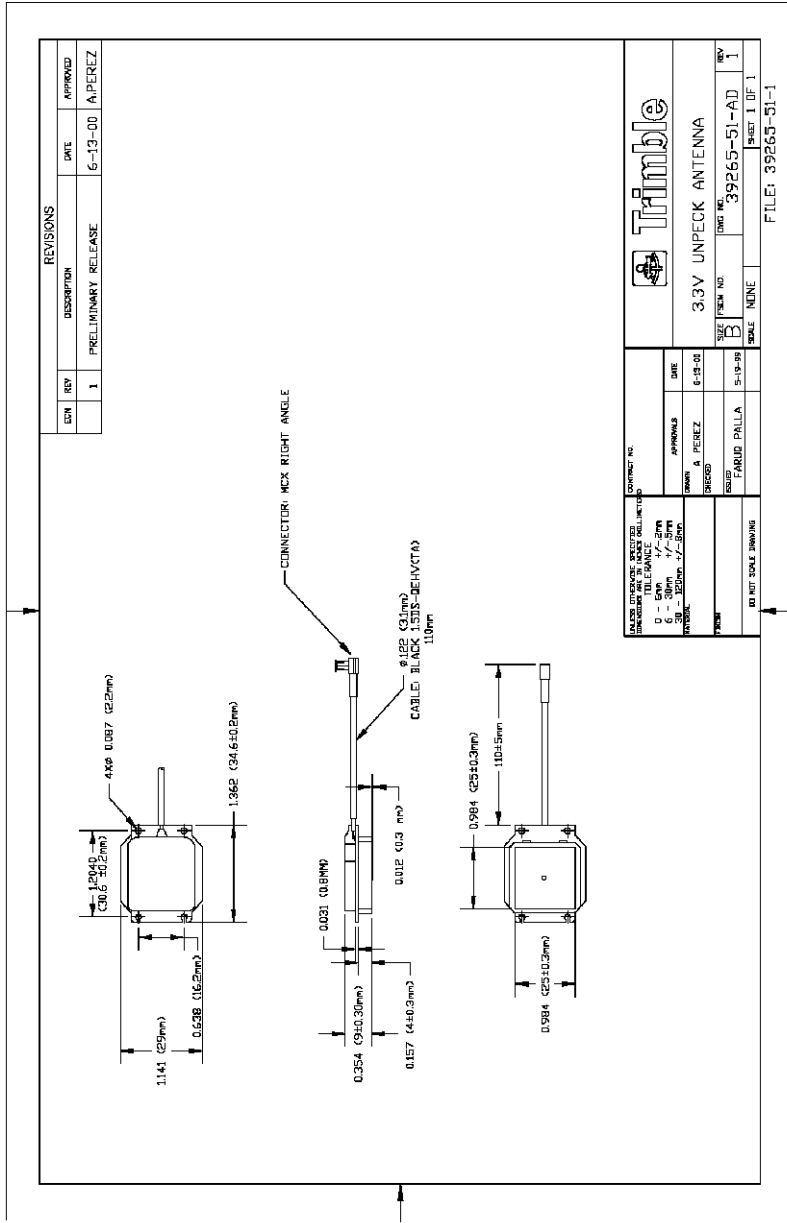

Antenna Transition Cable with MCX-HFL Connector

Part No. 47274

Rev. A

REV. A

DESCRIPTION

production release

DATE

12/23/02

APPROVED

D.C.

10 cm ± .2

Note:

1. For item 1 specification, reference std 50 Ohm MCX straight Bulkhead Jack Gold Plated, crimp style, and connector should be crimped attachment for item 3.
2. Connector, item 1, should have washer and nut installed.

Item	Description	Part #	Vendor	QTY
1	RF-ST. BH MCX CONN.	27-10-3-TGG	CHIN NAN	1
2	RF CONNECTOR	HFL-LP-DFS111	HIROSE	1
3	Cable	0.8DS-PBE or EQ	Sumitomo	1
4	WASHER	See item1 for spec.		1
5	NUT	See item1 for spec.		1

FORM NO. 101

REV. 10/04

DATE

APPROVALS

D.C.

SCALE

2X

SHEET 1 OF 1

Antenna Transition Cable with SMA-HFL Connector

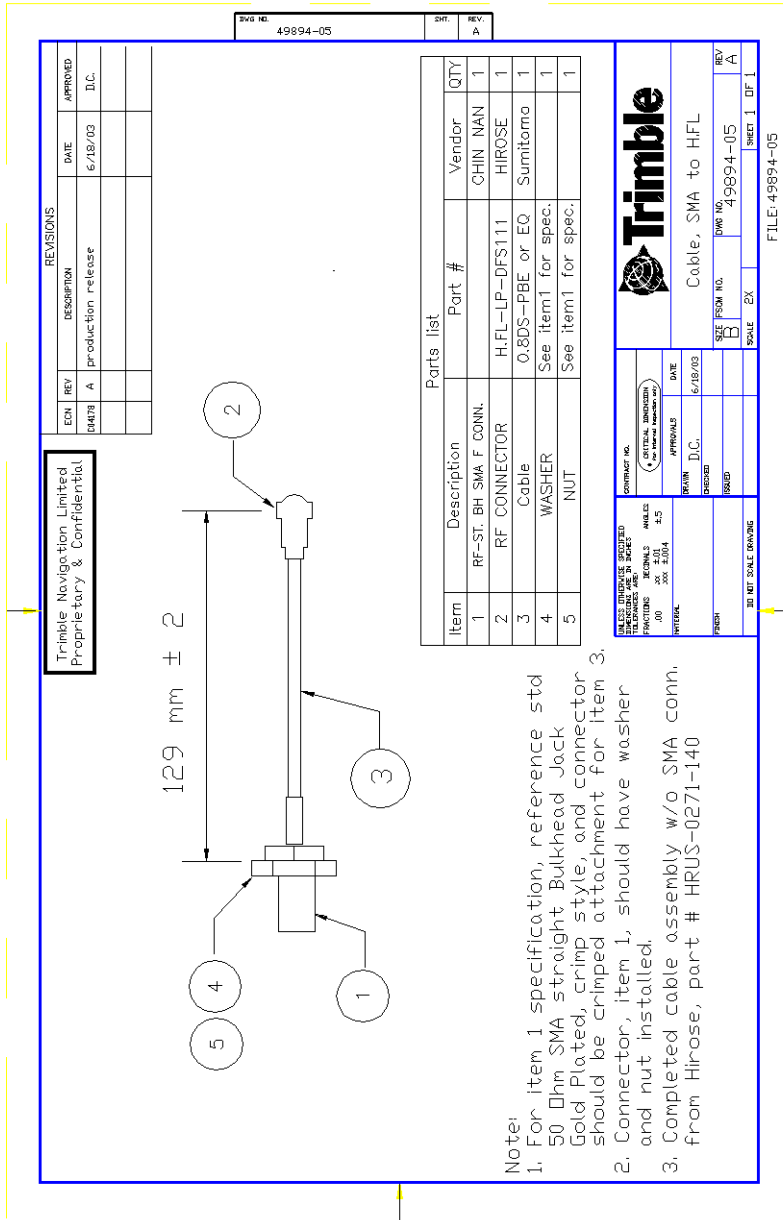

Glossary

This section defines technical terms and abbreviations used in this manual. It includes terms from the field of GPS technology.

2-D GPS mode	A procedure of determining a 2-D position using signals received from the best (or only) three available GPS satellites. Altitude is assumed to be known and constant. A 2-D position solution will only be determined if signals from three or more satellites are available.
2 dRMS	Twice the distance root mean squared. The error distance within which 95% of the position solutions will fall.
3-D	Three Dimensional. A 3-D position is defined as latitude, longitude, and altitude.
2-D	Two Dimensional. A 2-D position is defined as latitude, longitude, and altitude.
3-D GPS mode	A procedure of determining a 3-D position using signals received from the best (or only) four available GPS satellites. A 3-D position solution will only be determined if signals from four or more satellites are available.
almanac	A reduced-precision subset of the ephemeris parameters. Used by the receiver to compute the elevation angle, azimuth angle, and estimated Doppler of the satellites. Each satellite broadcasts the almanac for all the satellites in the system.
ASCII	American Standard Code for Information Interchange. A standard set of 128 characters, symbols and control codes used for computer communications. ASCII characters require 7 bits of data to send, but are often sent 8 bits at a time with the extra bit being a zero.

asynchronous communication	A method of sending data in which the bits can be sent at random times. Data transmission is not synchronized to a clock. With asynchronous transmission, each character is transmitted one at a time with a “start” bit at the beginning and one or more “stop” bits at the end. Any amount of time can elapse before the next character is sent. \
auto GPS mode	A procedure of automatically determining either a 2-D or 3-D position using signals received from GPS satellites. The solution automatically transitions between 2-D and 3-D depending on the number of satellites available, the PDOP of the available satellites, and the defined PDOP switch value. (See PDOP and PDOP constellation switch).
azimuth angle	The angle of the line-of-site vector, projected on the horizontal plane, measured clockwise from true North.
bandwidth	The range of frequencies occupied by a signal. Also, the information carrying capability of a communication channel or line.
baud	A measure of the speed of data transmission. Baud and bit rate are the same for direct equipment interconnections (e.g., via RS-232). Baud and bit rate are not the same for modulated data links, whether wire or radio.
bit	Binary digit. The smallest unit of information into which digital data can be subdivided and which a computer can hold. Each bit has only two values (e.g., on/off, one/zero, true/false).
bit rate	The rate at which bits are transmitted over a communication path. Normally expressed in bits per second (bps).
byte	A set of contiguous bits that make up a discrete item of information. A byte usually consists of a series of 8 bits, and represents one character.
C/A code	The Coarse/Acquisition code. This is the civilian code made available by the Department of Defense. It is subject to selective availability (SA). Users can reduce the effects of SA by using differential GPS.

carrier	The radio signal on which information is carried. The carrier can be sensed to determine the presence of a signal.
channel	Either a single frequency or a pair of radio frequencies used as a communication path.
chip	The length of time to transmit either a zero or a one in a binary pulse code.
chip rate	Number of chips per second (e.g., C/A code = 1.023 MHz).
configuration	A set of conditions or parameters that define the structure of an item. A configuration defines the GPS processing and characteristics of the RS-232 interface ports. The term configuration can also define the hardware components that comprise a subsystem or system.
data bits	The bits in a byte of data which carry the actual information.
datum	Refers to a mathematical model of the earth. Many local datums model the earth for a small region: e.g., Tokyo datum, Alaska, NAD-27 (North America). Others, WGS-84, for example, model the whole earth.
DCE	Data Communications Equipment. The equipment that provides the functions required to establish, maintain, and terminate a communication connection. Any equipment that connects to DTE using an RS-232 or CCITT V.24 standard interface.
default setting	A preset or initial value that is assumed to be the preferred or appropriate selection for most situations. The Lassen SK II GPS sensor is shipped with factory default configuration settings; the settings were determined by Trimble Navigation.
DGPS	see <i>differential GPS</i>
DGPS reference station	A device that tracks all GPS satellites in view, periodically performs inter-channel calibrations, and calculates and transmits differential corrections.
differential capable	A term used to describe a GPS receiver that is capable of receiving and applying differential GPS corrections.

differential GPS	A procedure of correcting GPS solutions to achieve improved position accuracy. Differential GPS provides 2 to 5 meter position accuracy. Differential accuracy is obtained by applying corrections determined by the stationary Differential GPS Reference Station to the GPS data collected by the RPU unit on-board the vehicle.
differential processing	GPS measurements can be differenced between receivers, satellites, and epochs. Although many combinations are possible, the present convention for differential processing of GPS phase measurements is to take differences between receivers (single difference), then between satellites (double difference), then between measurement epochs (triple difference).
differential relative positioning	Determination of relative coordinates of two or more receivers which are simultaneously tracking the same satellites. Static differential GPS involves determining baseline vectors between pairs of receivers. Also see <i>differential GPS</i>
dilution of precision	<p>A description of the purely geometrical contribution to the uncertainty in a position fix, given by the expression $DOP = \text{SQRT TRACE}(AA)$ where AA is the design matrix for the instantaneous position solution (dependent on satellite-receiver geometry). The DOP factor depends on the parameters of the position-fix solution. Standard terms for the GPS application are:</p> <p>GDOP: Geometric (three position coordinates plus clock offset in the solution)</p> <p>PDOP: Position (three coordinates)</p> <p>HDOP: Horizontal (two horizontal coordinates)</p> <p>VDOP: Vertical (height only)</p> <p>TDOP: Time (clock offset only)</p>
DOP	see <i>dilution of precision</i> .
Doppler aiding	The use of Doppler carrier-phase measurements to smooth code-phase position measurements.

Doppler shift	The apparent change in frequency of a received signal due to the rate of change of the range between the transmitter and receiver.
earth-centered earth-fixed	Cartesian coordinate system where the X direction is the intersection of the prime meridian (Greenwich) with the equator. The vectors rotate with the earth. Z is the direction of the spin axis.
elevation angle	The angle between the line of sight vector and the horizontal plane.
elevation mask angle	A measure of the minimum elevation angle, above the horizon, above which a GPS satellite must be located before the signals from the satellite will be used to compute a GPS location solution. Satellites below the elevation angle are considered unusable. The elevation mask angle is used to prevent the GPS receiver from computing position solutions using satellites which are likely to be obscured by buildings or mountains.
ellipsoid	In geodesy, unless otherwise specified, a mathematical figure formed by revolving an ellipse about its minor axis. It is often used interchangeably with spheroid. Two quantities define an ellipsoid; these are usually given as the length of the semimajor axis, a , and the flattening, $f = (a - b)/a$, where b is the length of the semiminor axis.
ephemeris	A set of parameters that describe the satellite orbit very accurately. It is used by the receiver to compute the position of the satellite. This information is broadcast by the satellites.
epoch	Measurement interval or data frequency, as in making observations every 15 seconds. Loading data using 30-second epochs means loading every other measurement.
firmware	A set of software computer/processor instructions that are permanently or semi-permanently resident in read-only memory.

frequency	<p>The number of vibrations per second of an audio or radio signal. Measured in hertz (Hz), kilohertz (kHz), or megahertz (MHz).</p> <p>GPS frequencies are: L1 = 1575.42 MHz L2 = 1227.60 MHz</p>
GDOP	<p>Geometric Dilution of Precision. GDOP describes how much an uncertainty in pseudo-range and time affects the uncertainty in a position solution. GDOP depends on where the satellites are relative to the GPS receiver and on GPS clock offsets.</p>
geodetic datum	<p>A mathematical model designed to best fit part or all of the geoid. It is defined by an ellipsoid and the relationship between the ellipsoid and a point on the topographic surface established as the origin of datum. This relationship can be defined by six quantities, generally (but not necessarily) the geodetic latitude, longitude, and the height of the origin, the two components of the deflection of the vertical at the origin, and the geodetic azimuth of a line from the origin to some other point. The GPS uses WGS-84.</p>
geoid	<p>The actual physical shape of the earth which is hard to describe mathematically because of the local surface irregularities and sea-land variations. In geodetic terms it is the particular equipotential surface which coincides with mean sea level, and which may be imagined to extend through the continents. This surface is everywhere perpendicular to the force of gravity.</p>
GPD	<p>GPS with differential corrections applied.</p>

GPS	Global Positioning System. A constellation of 24 radio navigation (not communication) satellites which transmit signals used (by GPS receivers) to determine precise location (position, velocity, and time) solutions. GPS signals are available world-wide, 24 hours a day, in all weather conditions. This system also includes 5 monitor ground stations, 1 master control ground station, and 3 upload ground stations.
GPS antenna	An antenna designed to receive GPS radio navigation signals.
GPS processor	An electronic device that interprets the GPS radio navigation signals (received by a GPS antenna) and determines a location solution. The GPS processor may also be able to apply (and determine) differential GPS corrections.
GPS receiver	The combination of a GPS antenna and a GPS processor.
GPS time	The length of the second is fixed and is determined by primary atomic frequency standards. Leap-seconds are not used, as they are in UTC. Therefore, GPS time and UTC differ by a variable whole number of seconds.
HDOP	Horizontal Dilution of Precision.
HOW	Handover word. The word in the GPS message that contains time synchronization information for the transfer from C/A to P-code.
interface cable (serial)	The interface cable allows data to flow between the Lassen SK II GPS and the communication equipment. One end of the cable has a 9-pin female RS-232 connector and the other end of this cable has a 9-pin male RS-232 connectors.
interference	Refers to the unwanted occurrences on communication channels that are a result of natural or man-made noises and signals, not properly a part of the signals being transmitted or received.
integrated Doppler	A measurement of Doppler shift frequency or phase over time.

IODE	Issue Of Data, Ephemeris. Part of the navigation data. It is the issue number of the ephemeris information. A new ephemeris is available usually on the hour. Especially important for Differential GPS operation that the IODE change is tracked at both the reference station and mobile stations.
jamming	Interference (in either transmitting or receiving signals) caused by other radio signals at exactly or approximately the same frequency
Kalman filter	A numerical method used to track a time-varying signal in the presence of noise. If the signal can be characterized by some number of parameters that vary slowly with time, then Kalman filtering can be used to tell how incoming raw measurements should be processed to best estimate those parameters as a function of time.
masks	See <i>satellite masks</i> .
maximum PDOP	A measure of the maximum Position Dilution of Precision (PDOP) that is acceptable in order for the GPS processor to determine a location solution (see PDOP).
NAVSTAR	The name given to the GPS satellites, built by Rockwell International, which is an acronym formed from NAVigation System with Time And Ranging.
NMEA	National Marine Electronics Association. An association that defines marine electronic interface standards for the purpose of serving the public interest.
NMEA 0183 message	NMEA 0183 is a standard for interfacing marine electronics navigational devices. The standard specifies the message format used to communicate with marine devices/components.
packet	An “envelope” for data, which contains addresses and error checking information as well as the data itself.
parity	A scheme for detecting certain errors in data transmission. Parity defines the condition (i.e., even or odd) of the number of items in a set (e.g., bits in a byte).

PDOP	Position Dilution of Precision. PDOP is a unitless figure of merit that describes how an uncertainty in pseudo-range affects position solutions.
PDOP constellation switch	A value, based on PDOP, that defines when the GPS receiver/processor should switch between 2-D and 3-D GPS modes. The PDOP constellation switch is only active when the GPS mode of operation is set to Auto.
PRN	Pseudo-random noise. Each GPS satellite generates its own distinctive PRN code, which is modulated onto each carrier. The PRN code serves as identification of the satellite, as a timing signal, and as a subcarrier for the navigation data.
protocol	A formal set of rules that describe a method of communication. The protocol governs the format and control of inputs and outputs.
pseudo-range	A measure of the range from the GPS antenna to a GPS satellite. Pseudo-range is obtained by multiplying the speed of light by the apparent transit time of the signal from the GPS satellite. Pseudo-range differs from actual range because the satellite and user clocks are offset from GPS time and because of propagation delays and other errors.
RAM	Random-Access Memory.
random-access memory	Memory in which information can be referred to in an arbitrary or random order. The contents of RAM are lost when the System Unit is turned off.
range	A term used to refer to the distance radio signals can travel before they must be received or repeated due to loss of signal strength, the curvature of the earth and the noise introduced because of moisture in the air surrounding the earth's surface.
range rate	The rate of change of range between the satellite and receiver. The range to a satellite changes due to satellite and observer motions. Range rate is determined by measuring the Doppler shift of the satellite beacon carrier.

read-only memory	Memory whose contents can be read, but not changed. Information is placed into ROM only once. The contents of ROM are not erased when the system unit's power is turned off.
real time clock	An electronic clock, usually battery powered, that keeps current time. Used by a GPS receiver during a warm or hot start to determine where to search for GPS satellite signals.
relative positioning	The process of determining the vector distance between two points and the coordinates of one spot relative to another. This technique yields GPS positions with greater precision than a single point positioning mode can.
rise/set time	Refers to the period during which a satellite is visible; i.e., has an elevation angle that is above the elevation mask. A satellite is said to “rise” when its elevation angle exceeds the mask and “set” when the elevation drops below the mask.
ROM	Read-Only Memory.
RS-232	A communication standard for digital data. Specifies a number of signal and control lines. RS-232 is often associated with a 25 pin connector called a DB-25.
RTCM	Radio Technical Commission for Maritime Services. Commission that recommends standards for differential GPS services. “RTCM Recommended Standards For Differential GPS Service,” prepared by RTCM Special Committee No. 104 (RTCM SC-104), defines a communication protocol for sending GPS differential corrections from a differential reference station to remote GPS receivers.
satellite masks	As satellites approach the horizon, their signals can become weak and distorted, preventing the receiver from gathering accurate data. Satellite masks enable you to establish criteria for using satellite data in a position solution. There are three types of satellite masks: Elevation, SNR, and PDOP.

SA	Selective Availability. This is the name of the policy and the implementation scheme by which unauthorized users of GPS will have their accuracy limited to 100 meters 2D RMS horizontal and 156 meters 2D RMS vertical.
SEP	Spherical Error Probability. The radius of a sphere such that 50% of the position estimates will fall within the surface of the sphere.
serial communication	A system of sending bits of data on a single channel one after the other, rather than simultaneously.
serial port	A port in which each bit of information is brought in/out on a single channel. Serial ports are designed for devices that receive data one bit at a time.
signal to noise level	GPS signals with SNRs that do not meet the mask criteria are considered unusable.
signal to noise ratio	A measure of the relative power levels of a communication signal and noise on a data line. SNR is expressed in decibels (dB).
SNR	Signal to Noise Ratio.
spread spectrum	The received GPS signal is a wide bandwidth, low-power signal (-160dBW). This property results from modulating the L-band signal with a PRN code in order to spread the signal energy over a bandwidth which is much greater than the signal information bandwidth. This is done to provide the ability to receive all satellites unambiguously and to provide some resistance to noise and multipath.
SPS	Standard Positioning Service. Refers to the GPS as available to the authorized user.
start bit	In asynchronous transmission, the start bit is appended to the beginning of a character so that the bit sync and character sync can occur at the receiver equipment.
stop bit	In asynchronous transmission, the stop bit is appended to the end of each character. It sets the receiving hardware to a condition where it looks for the start bit of a new character.

SV	Space Vehicle (GPS satellite).
synchronous communication	A method of sending digital data in which the bits come at fixed, rather than random, times and are synchronized to a clock.
TAIP	Trimble ASCII Interface Protocol. Designed originally for vehicle tracking applications, TAIP uses printable uppercase ASCII characters in 16 message types for easy integration with mobile data modems, terminals, and personal computers. The TAIP protocol is defined in full in Appendix C.
TANS	Trimble Advanced Navigation Sensor. Also refers to a Trimble-specified interface protocol for digital packet communication to/from the GPS receiver. Data output includes time-tagged position and velocity, satellite status, dilution of precision factors and diagnostics of GPS receiver operational status. Also see <i>TSIP</i>
TNL 4000RL	Trimble Navigation, Ltd. Reference Locator (4000RL). Product name for the Differential GPS Reference Station.
TSIP	Trimble Standard Interface Protocol. A binary/hex packet bi-directional protocol, also known as the TANS protocol. Used by a large number of Trimble sensors. TSIP is the subset of TANS which is recognized by all Trimble sensors except the 4000 series. The TSIP protocol is defined in full in Appendix A.

URA	Satellite user range accuracy. The URA is sent by the satellite and is computed by the GPS operators. It is a statistical indicator of the contribution of the apparent clock and ephemeris prediction accuracies to the ranging accuracies obtainable with a specific satellite based on historical data.
UTC	Universal Time Coordinated. Uniform atomic time system/standard that is maintained by the US Naval Observatory. UTC defines the local solar mean time at the Greenwich Meridian.
UTC offset	The difference between local time and UTC (Example: UTC - EST = 5 hours).

